



audioquest®

EURO RETAIL

WWW.NEXUSACOUSTICS.COM

THE NEXUSACOUSTICS BLOGSPOT

2023

TABLE OF CONTENTS

USB Digital-Audio Converters

DragonFly DACs	7
JitterBug FMJ USB Noise Filter	7
USB Extenders and Adaptors	7

AC Power

Power Conditioners	9
Power Cables	11-12
Power Plugs	12
Adaptors	14
Fog Lifters (Cable Risers)	14

Speaker Cables

Q2	18
Type Series	18
Rocket Series	19
Folk Heroes	20-22
Mythical Creatures	22-24
BiWire Jumpers	25
Fog Lifters (Cable Risers)	25
Binding Post Wrench	25

Audio Interconnect Cables

Bridges & Falls	27
Rivers & Mythical Horses	28
Mythical Creatures	29
Adaptors, Splitters, Couplers	30
PreAmp Jumpers	30

Subwoofer Cables

31

Tonearm & Turntable Cables

33

Vinyl Accessories

GroundGoody Tonearm & Ground Wires	35
Record Brushes	35

Headphone Accessories

Headshell Leads	35
NightBird Headphone Cable	35
Headphone Plug Adaptor	35
Perch Headphone Stand	35

HDMI Cables

8K (48Gbps)	38
4K (18Gbps) & 8K (48Gbps) Long-Length	39
8K (48Gbps) eARC-Priority	39
Adaptors, Coupler	40

Digital-Audio Interconnect Cables

USB Cables and Adaptors	42-43
Optical Cables and Adaptor	44
Digital Coax Cables and Adaptor	45
AES/EBU (Balanced) Cables	46
Ethernet Cables (RJ/E)	47

Accessories

DBS Pack	48
Q-Feet System	48
Fog Lifters (Cable Risers)	48
CleanScreen	48
Sorbothane Self-Stick Sheet	48
Cable Clips	48
Adaptors, Splitters, Couplers	49
Antenna Cables - HD6 Forest	49
RCA, XLR, Coax	
Plugs and Connectors	50
Noise-Stopper Caps	51

Tools

Crimp Tools, Cable Cutters, and Wire Strippers	52
Silver Solder	52

Instant Tool-less Connectors (ITC)

Cable Stripper	53
Bulk Cables	53
Connectors	53

Bulk Speaker Cables (Spools)

CL3/FT4 In-Wall Rated Speaker Cables	54
Speaker Cables — Not In-Wall Rated	55
SureGrip® Speaker Connectors	56
Spade, Pin, and Banana Connectors	57
Termination Pants	57

Bulk Audio Interconnect Cables (Spools)

CL3/FT4 In-Wall Rated Audio Interconnect Cables and Plugs	58
--	----

Bulk Ethernet Cables (Spools)

CL3/FT4 In-Wall Rated CAT6 and CAT7 Ethernet Cables & Plugs	59
--	----

Installer Packs

Cables, Splitters and Adaptors in Single, Packs of 5 and 10	60-61
--	-------

POP Materials

Wall Signs, Tent Card, Window Sticker	62
Spool Holder	62
In-Store Display Racks	62

Promotional Items

Polo, T-shirt, Jacket	63
Baseball Cap, Beanie	63
Pen	63
Water Bottle	63
License Plate Frame	64
Backpacks, Tote Bag	64

Index	65-66
--------------	-------

Terms and Conditions

- Prices are subject to change without notice.
- All prices are in Euro.
- As used throughout this price book, "Retail" carries the same meaning as Suggested Retail Price (SRP).

Returns

- All returns are subject to approval by AudioQuest.
- Built-to-order products may not be returned.
- All sales are final for custom speaker cables produced at 2m or less.
- A Return Merchandise Authorization (RMA) number must be issued by AudioQuest before any product may be returned.
- The RMA number must appear on the outside of the shipping carton, near or on the address label.

Contact Information

AudioQuest
Hoge Bergen 10
4704 RH Roosendaal
The Netherlands
www.audioquest.com
Tel: +31 165 54 1404

Email orders and related correspondence: orders@audioquest.nl

Email all other correspondence to: info@audioquest.nl

Copyright © 2022 AudioQuest.
All rights reserved.
E & OE. In the interests of continuous product improvement, all specifications are subject to change without notice.

AudioQuest: Doing No Harm Since 1980



William (Bill) Low
Founder / CEO

For 40 years now, AudioQuest, headquartered in Irvine, California, has been a leading developer, manufacturer, and distributor of high-performance audio/video products and custom-install solutions. Although best known for our comprehensive range of analog, digital, and AC power cables, our portfolio has expanded to a diverse assortment of products, including the multi-award-winning DragonFly DACs, LYRA, and Niagara and PowerQuest power products.

Our ultimate goal is the same today as it was 40 years ago: Do No Harm! By this we mean that all cables and components, to the extent that is technologically feasible, should get out of the music's way by inducing the least amount of noise and distortion.

The Evolution Continues: The Four Elements Today

While minimizing noise and damage to the audio signal remains the North-Star constant, the ways in which AudioQuest engages these challenges always evolves. While there are still Four Elements that describe our foundational materials and design philosophies, a growing number of technologies cross and even go beyond our original Four Elements. Many have become crucial enough to demand visibility. Noise-Dissipation is an umbrella Element under which many of these meaningful techniques and technologies will reside. While Geometry is no longer identified as one of The Four Elements, it remains inextricably tied to all other Elements of cable design and manufacture.

Solid Conductors: Strand interaction remains the biggest potential source of distortion in cables. Solid Conductors are the aspirational ideal and most complete solution to this problem. However, thoughtfully arranged multi-conductor geometries such as concentric windings are used to create our Semi-Solid Conductor technologies. These avoid many strand-distortion mechanisms and are in their own right ideal in a growing number of applications.

Directionality: All drawn metal conductors have a non-symmetrical, fish-scale-like grain structure. Because the highest Radio Frequencies (RF) are subject to skin effect, traveling on this deformed outer-surface layer of the conductor, there is a resulting increase in RF impedance in one direction versus the other. Since induced RF noise is parasitic (and doesn't travel with the primary signal current), it takes the path of least resistance. At AudioQuest, we test every conductor so it is used in the direction that drains the induced noise away from where it will cause the most harm, optimizing the cable and the system's performance.

Noise-Dissipation: Unwanted Radio-Frequency (RF) noise is and has always been picked up and induced into cable. This contamination ultimately masks and distorts critical portions of the audio/video signal. As this distortion-causing (parasitic) RF signal is more present today than at any previous time in history, we must depend on a wider arsenal of Noise-Dissipation technologies:

- ZERO-Tech (No Characteristic Impedance) applies Ultra-Linear Noise-Dissipation across the widest range of frequencies possible. It also enables uncompressed transient current transfer for AC power and loudspeaker/power amplifier applications.
- RF/ND-Tech (Patented Radio-Frequency Ground-Noise Dissipation) minimizes circuit misbehavior by cancelling induced RF noise.
- Tried-and-true DBS (Dielectric-Bias System) has evolved to include RF-Noise Traps that further reduce dielectric distortion and induced noise.

Metal Quality: Higher-purity conductor metals with smoother surfaces and internal crystal structures greatly reduce noise and distortion. Carefully finessed mixes of metals and conductor sizes can be effectively used to define a cable's Sonic Signature—a cost-effective technique for high-value, high-performance models.

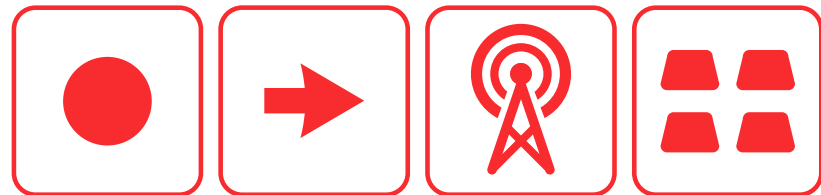

Solid Conductors

Directionality

Noise-Dissipation

Metal Quality

DragonFly

Naturally Beautiful Sound at Your Fingertips—Whenever and Wherever You Want It

With today's smartphones, tablets, and computers, music and videos are far more accessible than ever before.

Unfortunately, the digital-to-analog converters (DACs) inside these devices are highly compromised, even when the sample-rate numbers (24/192, etc.) look impressive. These built-in DACs may make audible sound, but they don't make beautiful music.

A DragonFly bypasses the compromised audio circuitry within these devices to deliver naturally beautiful sound to earbuds, headphones, desktop speakers, or complete audio systems.

Whether using a free streaming service, premium High-Resolution or MQA-encoded streaming (such as Tidal Masters), or playing MP3 files or videos, all DragonFlies make these experiences much more compelling and immersive.

DragonFly Black delivers great performance and value. Red ups the game with more power, more grip, and deeper sonic immersion. Now, DragonFly Cobalt, with its more advanced processor, microcontroller, and RF noise filtering, provides even greater clarity, dynamics, and finesse than previously possible.



DragonFly DAC + Preamp + Headphone Amp

- Plays all music files: MP3 to High-Res and MQA
- Compatible with Apple® and Windows® PCs
- Compatible with iOS devices (requires Apple Lightning to USB 3 Camera Adaptor)
- Compatible with Android devices (requires DragonTail or other USB Adaptor for Android Devices)
- Bit-perfect variable output drives headphones, powered speakers, or power amp
- Fixed output feeds preamp or receiver



	DragonFly Black	DragonFly Red	DragonFly Cobalt
Output	1,2 volts	2,1 volts	
DAC Chip	ESS ES9010 with minimum-phase fast roll-off filter	ESS ES9016 with minimum-phase fast roll-off filter	ESS ES9038Q2M DAC chip with minimum-phase slow roll-off filter for more natural sound
Volume Control	Analog Volume Control	64-Bit Bit-Perfect Digital Volume Control	
Desktop Compatibility	Windows 7 and later; Apple 10.6.8 and later; Linux (no tech support provided)		
Mobile Compatibility	Apple iOS 5 and later; Android 5,0 and later		
Included Adaptor			DragonTail A to C Adaptor
Accessories	Protective Endcap, Leatherette Pouch		
Dimensions	62mm (l) x 19mm (w) x 12mm (h)	62mm (l) x 19mm (w) x 12mm (h)	57mm (l) x 19mm (w) x 12mm (h)
	Euro Retail: 119,00	Euro Retail: 229,00	Euro Retail: 329,00

JitterBug FMJ USB 2.0 Noise Filter (Data & Power)

- Enables more spacious and compelling sound
- Dual Discrete Noise-Dissipation Circuits reduce all forms of internal noise in both the sending and receiving electronics
- Full Metal Jacket (FMJ) with hinged Carbon-Loaded Noise-Dissipation input cover protects against external noise
- Reduces jitter and packet errors
- Use one JitterBug in series with almost any USB DAC, including DragonFlies Black and Red; experiment with DragonFly Cobalt
- For an additional improvement, use a second JitterBug in parallel—always desirable with DragonFly Cobalt

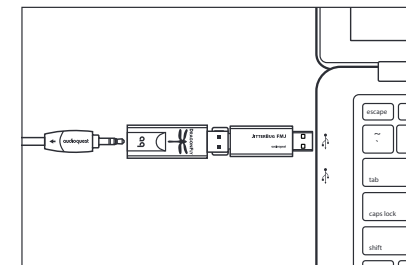

Euro Retail: 69,00

USB Extenders and Adaptors

DragonTail USB Extenders feature 5% Silver Solid Conductors and are Direction-Controlled for reduced RF noise.



DragonTail USB A 2.0 Extender
Female USB A to Male A

Euro Retail: 29,95



DragonTail USB A to Micro Adaptor
Female USB A to Male Micro

Euro Retail: 29,95



DragonTail A to C Adaptor
(included with DragonFly Cobalt)

Euro Retail: 29,95

AC Power Conditioners

Niagara and PowerQuest: Low-Z Power | Noise-Dissipation Systems

Redefining the science of AC power conditioning

What is a power conditioner and why is it necessary?

For some, a power conditioner is merely a device that provides enough outlets for the entire audio/video system while also protecting the connected devices from electrical storms and wiring faults. Yet, for the discriminating listener, many power conditioners can make an audio/video system perform far worse.

Yes, a home or building may have dimming lights or an occasional brown-out, and the utilities' AC sine wave is always far from perfect. However, where incoming power is concerned, there are two reasons an audio/video system does not perform up to its full potential: 1) The current transients that supply the power amplifier are compressed, and 2) The ever-increasing levels of radio-frequency noise are masking (covering up) the system's low-level signal content.

When compared to or measured against either Niagara or PowerQuest, a simple power bar or a dedicated AC wall outlet can lose up to a third of the low-level audio information that contain much of a recording's harmonics, imaging, high frequencies, and bottom-end grip—and once that information is gone, it's gone forever.

AudioQuest's Niagara and PowerQuest technologies are unique amongst all power products—whether they're isolation transformers, AC regenerators, battery back-up, re-clocking devices, or other types. Niagara and PowerQuest filters and Ground-Noise Dissipation work evenly, or linearly, across a far wider range of induced noise frequencies. Additionally, Niagaras 3000, 5000, and 7000 feature Transient Power Correction, which supplies a current reservoir to greatly bolster the performance of any power amplifier.



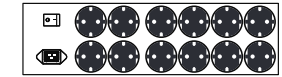
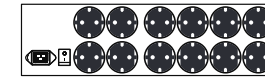
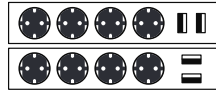

	PowerQuest 2	PowerQuest 3	Niagara 1200	Niagara 3000	Niagara 5000	Niagara 7000
Linear Noise-Dissipation Technology	More than 18 octaves of differential filtering	More than 18 octaves of differential filtering; 14 octaves common-mode filtering	Level-X More than 19 octaves of differential filtering	Level-X More than 21 octaves differential-mode filtering	Level-X More than 23 octaves differential-mode filtering; 16 octaves common-mode filtering	Level-X More than 23 octaves differential-mode filtering; 20 octaves common-mode filtering
Patented Ground-Noise Dissipation	1 outlet	2 outlets	2 banks (all outlets)	3 banks (all outlets)	6 banks (all outlets)	6 banks (all outlets)
Non-Sacrificial Surge Protection	Withstands multiple AC surges and spikes up to 6000V/3000A without sustaining damage		Sonically Non-Invasive; Withstands multiple AC surges and spikes up to 6000V/3000A without sustaining damage			
Transient Power Correction	N/A	N/A	N/A	55 amps peak; Provides a current reservoir for any power amplifier (up to 25mS)	80 amps peak; Provides a current reservoir for any power amplifier (up to 25mS)	80 amps peak; Provides a current reservoir for any power amplifier (up to 25mS)
Patented DBS Symmetrical Power Isolation Transformer	N/A	N/A	N/A	N/A	N/A	2 (source component outlet banks)
Maximum RMS Current	10 Amps (RMS) @ 220-240v	10 Amps (RMS) @ 220-240v	10 Amps (RMS) @ 220-240v	10 Amps (RMS) @ 220-240v	16 Amps (RMS) @ 220-240v	16 Amps (RMS) @ 220-240v
Outlets	6 total: (1) 4K/8K Video, (3) Source, (2) High-Current	8 total: (2) 4K/8K Video, (4) Source, (2) High-Current	7 total: (5) Source (including video), (2) High-Current	7 total: (5) Source (including video), (2) High-Current	12 total: (8) Source (including video), (4) High-Current	12 total: (8) Source, (4) High-Current
USB-A Charging Ports	2 high-speed ports (3.4 amp capacity)	4 high-speed ports (4.8 amp capacity)	N/A	N/A	N/A	N/A
Power Cable	Direction-Controlled Semi-Solid Concentric - 2,1m long		Power cable not included - For optimal results use a cable that features ZERO and GND Technology			
Signal Line Protection	N/A	Network	N/A	N/A	N/A	N/A
Dimensions	393mm L x 80mm W x 153mm H (Includes wall-mounting holes and detachable base)	393mm L x 80mm W x 188mm H (Includes wall-mounting holes and detachable base)	493mm W x 81mm H x 190mm D	445mm W x 88mm H x 386mm D (2-RU rack mount kit included)	445mm W x 133mm H x 437mm D (3-RU rack mount kit on request)	445mm W x 133mm H x 437mm D (3-RU rack mount kit on request)
Weight	2,2 kg	2,5 kg	8,2 kg	11,3 kg	17,2 kg	39 kg
	Euro Retail: 269,00	Euro Retail: 399,00	Euro Retail: 1.299,00	Euro Retail: 3.995,00	Euro Retail: 5.995,00	Euro Retail: 10.995,00

AC Power Cables

Low-Z | Noise-Dissipation NRG, Wind, and Storm Series

The power cables that are supplied with most audio/video components have many admirable features. They're durable, flexible, small, and they will unfailingly supply the required AC voltage from the utilities' service tap for many years to come. They're also inexpensive.

Unfortunately, these "commodity" power cables were never up to the task of supplying sensitive components with the quality power they need. By this, we mean power that is unrestricted when delivering current transients to a power amplifier. The power cable must not add noise to the audio/video signal via RF (radio-frequency) noise that is induced into, or picked up by, the AV component. The ground lead is the worst offender in this regard, as it has no component power supply to help lessen the damage from the induced RF noise. Typically, the ground noise drains directly towards the component's signal path.

Even with an advanced AC power system like Niagara or PowerQuest, the AC power cable is a branch of noise-dissipation system. Like plumbing, the RF noise must be drained away from the circuits upon which it could do harm. Many ask, if my wall wiring is so many yards in length, how can a 6-foot cable possibly matter? It matters for the same reason four square inches of mud and debris can back up a plumbing system or a rain gutter. The drainage or distribution of water currents and noise currents work in the exact same manner. They are one system.

With AudioQuest AC power cables and our unique technologies such as ZERO-Tech (No Characteristic Impedance) and our patented RF/ND-Tech, you will experience greater dynamics, bass grip, extended high frequencies, and the blackest background you've ever heard.

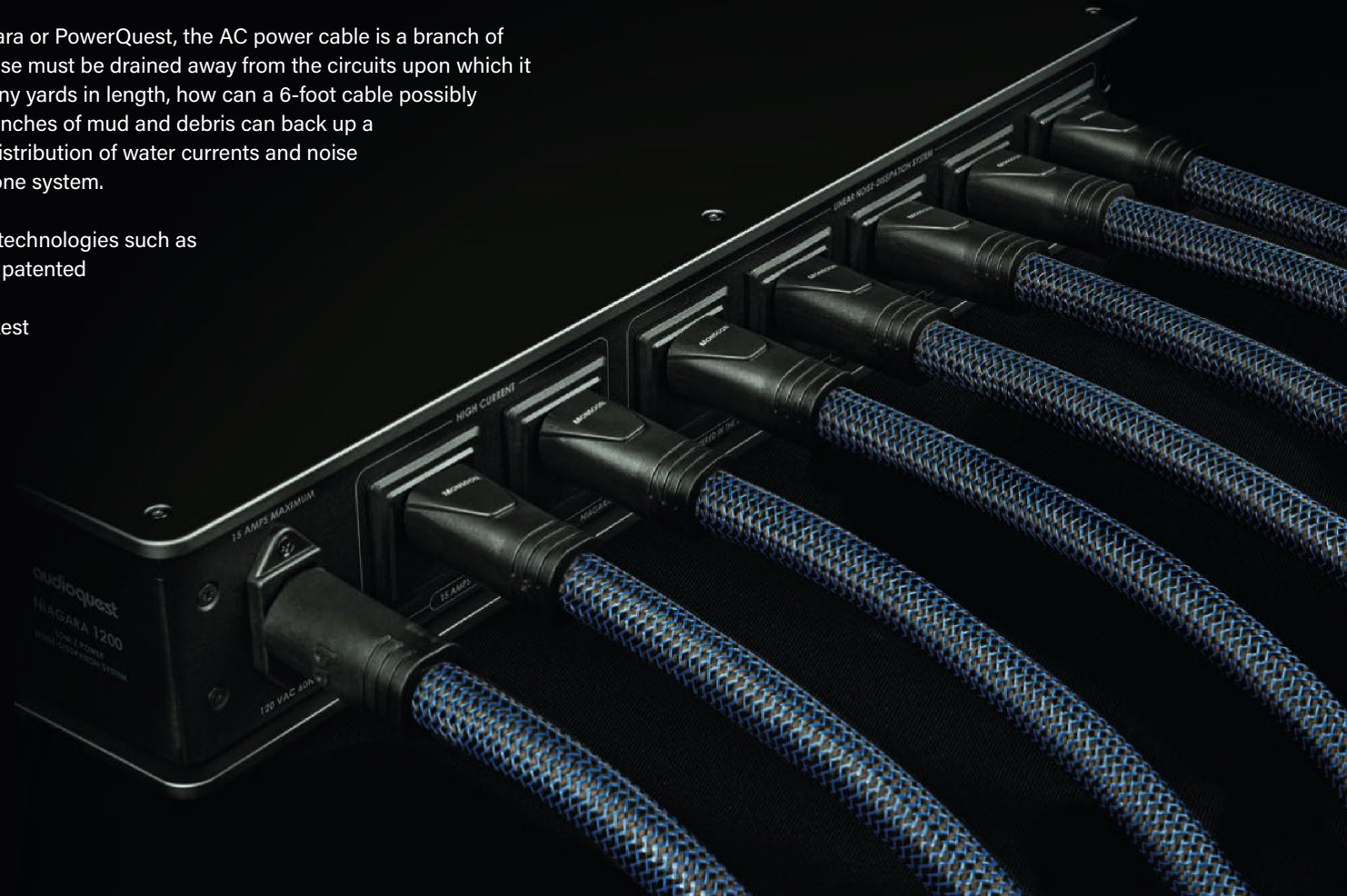

AC Power Cables: NRG Series

NRG AC cables available in Installer 5-Packs, page 58.

C5
2,5A Maximum RMS Capacity @ 230VAC 50Hz

C7
2,5A Maximum RMS Capacity @ 230VAC 50Hz



C13
10A Maximum RMS Capacity @ 230VAC 50Hz



NRG-Y2 and NRG-Z2 cables use a 2-pole C7 connector—and yet feature a 3-prong wall plug. The additional ground connection is necessary to enable ZERO-Tech, and to maximize RF-Noise Dissipation.



Model	NRG-X2	NRG-Y2	NRG-Z2	NRG-X3	NRG-Y3	NRG-Z3
Metal	Semi-Solid Concentric LGC		Semi-Solid Concentric PSC+	Semi-Solid Concentric LGC		Semi-Solid Concentric PSC+
Gauge	1,04mm ² (2,5 Amp @ 220-240V)			1,31mm ² (C13 Plug: 10 Amp @ 220-240v, C5 Plug: 2,5 amps @ 220-240v)	2,08mm ² (C13 Plug: 10 Amp @ 220-240v)	2,08mm ² (10 Amp @ 220-240v)
Technology	-	ZERO Tech (No Characteristic Impedance)			ZERO Tech (No Characteristic Impedance)	ZERO Tech (No Characteristic Impedance); Patented RF/ND-Tech
Jacket	Black PVC with Red Stripes	Dark Gray/Black Braid	Dark Red/Black Braid	Black PVC with Red Stripes	Dark Gray/Black Braid	Dark Red/Black Braid
Terminations	Cold-Welded Connectors					
Length	Euro Retail	Euro Retail	Euro Retail	Euro Retail	Euro Retail	Euro Retail
1m	74,95	134,95	209,00	89,95	159,95	259,00
2m	89,95	159,95	269,00	109,95	199,95	359,00
3m	104,95	184,95	329,00	129,95	239,95	459,00
4,5m	129,45	-	-	159,95	-	-
6m	149,95	-	-	189,95	-	-



C17
For components that use the ungrounded C17 connector, please use AQ cables with a C13 connector. The grounded male plug is necessary to make use of our Noise-Dissipation System.

Note: NRG-X3 with C5 connector is available in 1m, 2m & 3m only

AC Power Cables: Wind Series

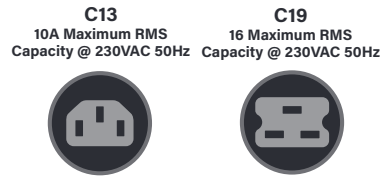

Never assume which of these is required for a component or power conditioner. Some manufacturers prefer the performance of one IEC inlet type over another—even when their circuit's current draw is minimal.



XTRM cables have upgraded plugs equivalent in quality to the Storm Series plugs.

Wind Series Plugs

Wind XTRM Plugs Built From Storm-Level Components

Model	Monsoon	Monsoon XTRM	Blizzard ● 72v DBS	Blizzard XTRM ● 72v DBS	Silver Cloud ● 72v DBS	Silver Cloud XTRM ● 72v DBS
Plug Type	Direct-Gold Plated Molded	Hanging-Silver over Red and Beryllium Coppers	Direct-Gold Plated Molded	Hanging-Silver over Red and Beryllium Coppers	Direct-Gold Plated Molded	Hanging-Silver over Red and Beryllium Coppers
Metal	Semi-Solid True-Concentric Perfect-Surface Copper+ (PSC+) and Long-Grain Copper (LGC)		Semi-Solid True-Concentric Perfect-Surface Copper+ (PSC+)		Semi-Solid True-Concentric Perfect-Surface Silver (PSS) and Perfect-Surface Copper+ (PSC+)	
Gauge	3,31mm ²					
Technology	ZERO-Tech (No Characteristic Impedance) for Uncompressed Current Transfer; RF/ND-Tech					
Jacket	Dark Blue/Black Braid 	Silver/Black Braid 		Black/Black Braid 		
Terminations	Direct-Gold and Silver Plated; Cold-Welded Connectors					
Length	Euro Retail	Euro Retail	Euro Retail	Euro Retail	Euro Retail	Euro Retail
1m	459,00	809,00	769,00	1.119,00	2.149,00	2.499,00
2m	619,00	969,00	989,00	1.339,00	3.749,00	4.099,00
3m	779,00	1.129,00	1.209,00	1.559,00	5.349,00	5.699,00
Other prepared lengths use formula:	-	160,00/m + 649,00	-	220,00/m + 899,00	-	1.600,00/m + 899,00

Mistral AC Power Bulk Cable

Metal: Semi-Solid True-Concentric Perfect-Surface Copper+ (PSC+) and Long-Grain Copper (LGC)

Gauge: 3,31mm²

Technology: RF/ND-Tech

Jacket: Dark Gray/Light Gray PVC

Terminations: Mistral AC Power Plugs

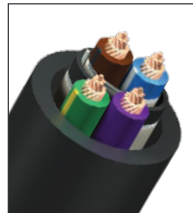

50m Spool
Retail: 130,00/m

Mistral AC Power Plugs

Sold separately.



Mistral Wall Plug
Retail: 149,00



Mistral IEC C-13 Plug
Retail: 149,00



Mistral IEC C-19 Plug
Retail: 149,00





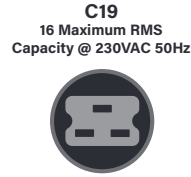
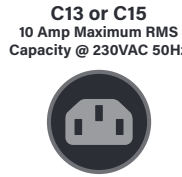



AC Power Cables: Storm Series

Never assume which of these is required for a component or power conditioner. Some manufacturers prefer the performance of one IEC inlet type over another—even when their circuit's current draw is minimal.





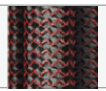
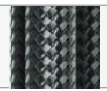

Plugs for Storm Series

High (Variable) Current AC Power Cables - Optimized for use with AC power conditioners/regenerators, power amplifiers, and any components that contain a built-in power amplifier, including AV receivers, powered speakers, and powered subwoofers.

Model	 Thunder 72v DBS	 Tornado 72v DBS	 Hurricane 72v DBS	 FireBird 72v DBS	 Dragon 72v DBS
Conductor Metal	Solid Perfect-Surface Copper+ (PSC+) plus Long-Grain Copper (LGC)	Solid Perfect-Surface Copper+ (PSC+)		Solid Perfect-Surface Silver (PSS) plus Solid Perfect-Surface Copper+ (PSC+)	Solid Perfect-Surface Silver (PSS)
RF Drain Metal	Solid 6% Silver		Solid Perfect-Surface Silver (PSS)		
Technology	ZERO-Tech (No Characteristic Impedance) for Uncompressed Current Transfer; RF/ND-Tech				
Jacket	Brown/Black Braid 	Silver/Black Braid 	Dark Blue/Black Braid 	Dark Red/Black Braid 	Black/Black Braid 
Termination and Gauge	Hanging-Silver over Red and Beryllium Copper - 4,17mm ² Line and Neutral - 3,31mm ² Ground				
Length	Euro Retail	Euro Retail	Euro Retail	Euro Retail	Euro Retail
1m	1.099,00	1.499,00	1.999,00	3.699,00	5.899,00
2m	1.349,00	1.899,00	2.899,00	6.299,00	10.699,00
3m	1.599,00	2.299,00	3.799,00	8.999,00	15.499,00
Other prepared lengths use formula:	250,00/m + 849,00	400,00/m + 1.099,00	900,00/m + 1.099,00	2.600,00/m + 1.099,00	4.800,00/m + 1.099,00

Constant-Current (Source) AC Power Cables - Optimized for use with audio/video source components, which have a constant or "fixed" current draw.

Model	-	 Tornado 72v DBS	 Hurricane 72v DBS	 FireBird 72v DBS	 Dragon 72v DBS
Conductor Metal	-	Solid Perfect-Surface Copper+ (PSC+)		Solid Perfect-Surface Silver (PSS)	
RF Drain Metal	-	Solid 6% Silver		Solid Perfect-Surface Silver (PSS)	
Termination and Gauge	-	Hanging-Silver over Red and Beryllium Copper - 1,31mm ² Line, Neutral and Ground			
Length	-	Euro Retail	Euro Retail	Euro Retail	Euro Retail
1m	-	1.199,00	1.539,00	3.099,00	4.699,00
2m	-	1.399,00	2.079,00	5.199,00	8.399,00
3m	-	1.599,00	2.619,00	7.299,00	12.099,00
Other prepared lengths use formula:	-	200,00/m + 999,00	540,00/m + 999,00	2.100,00/m + 999,00	3.700,00/m + 999,00

AC Power Accessories



IEC90°/1
Adaptor Bends in
Direction of 1 Center
Retail: 22,95



IEC90°/2
Adaptor Bends in
Direction of 2 Outer Pins
Retail: 22,95

Female to Male IEC C-13 Adaptors

Premium Single-Piece
Metal Conductors from
Input to All Outputs
Preserve Advantages
of Superior AudioQuest
NRG Series AC Cables.



C7 90° Adaptor Kit

- Provides 90° bends for C7 power connections
- Also connects for double bends
- Non-polarized for maximum flexibility

Package contains:

- 1 x "E" adaptor
- 1 x "U" adaptor

Retail: 45,90

**C7 90° Adaptors also available in
Installer 5-Packs, page 60.**

Fog Lifters

Reduce the RF noise that capacitively couples into cables through all solid materials (carpet, stone, wood, etc.)

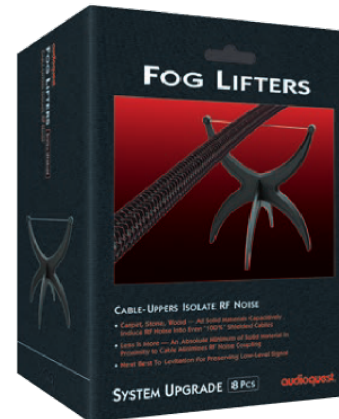

Set of 8
Retail: 159,00

Speaker Cables

Meticulously Designed to Minimize Noise and Distortion

Do No Harm: The Four Elements Today

AudioQuest's Four Elements are always applied in the most thoughtful, effective ways to offer the best performance for the money—at all price points. While our implementation of these techniques has evolved over the years, our guiding principle remains the same: *Do No Harm*.

Solid Conductors

Strand interaction remains the biggest potential source of distortion in cables. Solid Conductors are the aspirational ideal and most complete solution to this problem. However, thoughtfully arranged multi-conductor geometries such as concentric windings are used to create our Semi-Solid Conductor technologies. These avoid many strand-distortion mechanisms and are in their own right ideal in a growing number of applications.

High-Purity Metal

Higher-purity conductor metals with smoother surfaces and internal crystal structures greatly reduce noise and distortion. Carefully finessed mixes of metals and conductor sizes can be effectively used to define a cable's *Sonic Signature*—a cost-effective technique for high-value, high-performance models.

Noise-Dissipation

Unwanted Radio-Frequency (RF) noise is and has always been picked up and induced into cable. This contamination ultimately masks and distorts critical portions of the audio/video signal. As this distortion-causing (parasitic) RF signal is more present today than at any previous time in history, we must depend on a wider arsenal of Noise-Dissipation technologies:

- Directionally Controlled conductors minimize high-frequency noise by “directing” or draining it away from the most vulnerable circuits.
- ZERO-Technology (No Characteristic Impedance) applies Ultra-Linear Noise-Dissipation across the widest range of frequencies possible. It also enables uncompressed transient current transfer for AC power and loudspeaker/power amplifier applications.
- RF/ND-Tech (Patented Radio-Frequency Ground-Noise Dissipation) minimizes circuit misbehavior by cancelling induced RF noise.
- Tried-and-true DBS has evolved to include RF-Noise Traps that further reduce dielectric distortion and induced noise.

Dielectric

Insulation is necessary between conductors to minimize signal interaction and electrical shorts. The ideal is virtually no dielectric interaction (such as is achieved with our ZERO-Technology). However, by optimizing the dielectric material between signal conductors, this distortion is greatly minimized.



Speaker Cable Applications

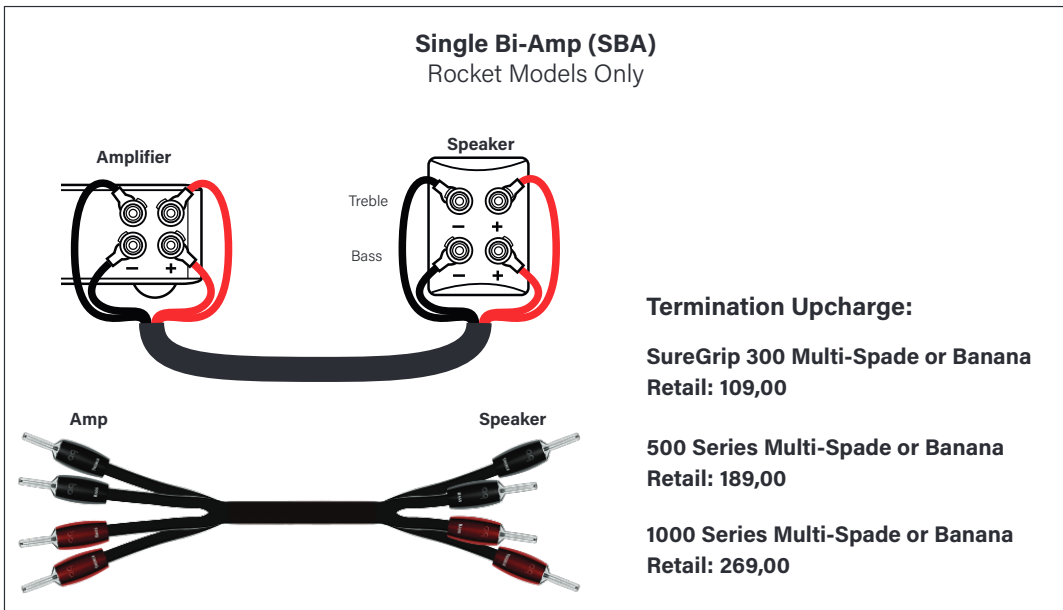
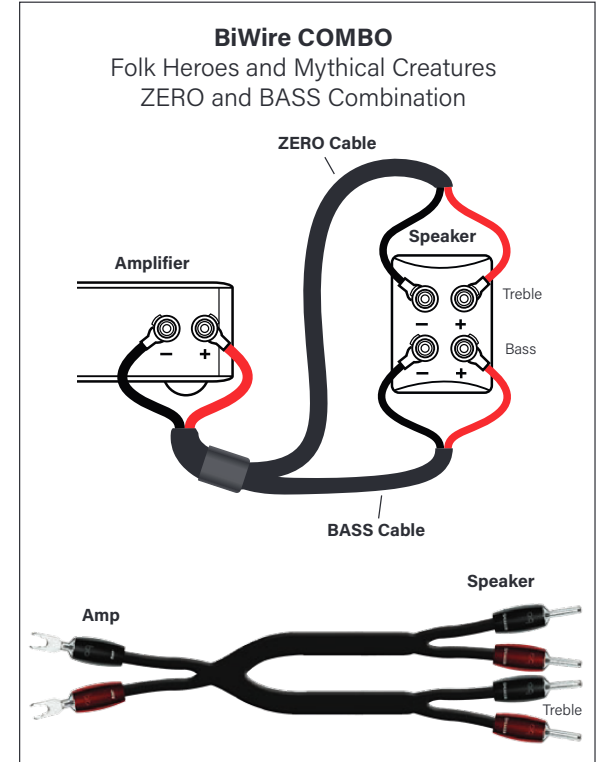
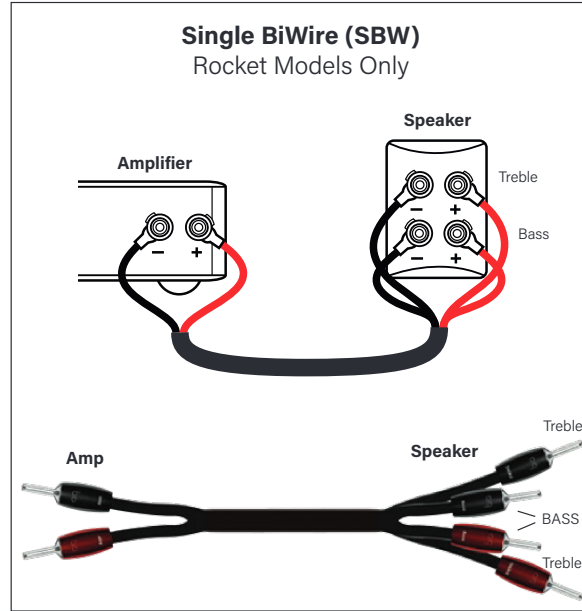
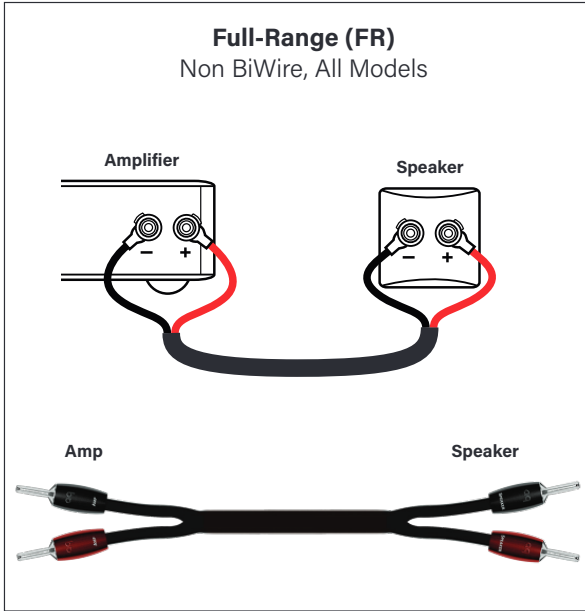

Mythical Creature & Folk Hero Termination Options: Bananas or Spades?

Amplifier-End Connector:

Choice of 1000 Series Multi-Spade, Banana, U-Spade, or V-Spade (Silver only)



Insulated (compliant) binding posts may not allow for 2 sets of connectors.

Often, the choice between terminating speaker cables with spade lugs or banana plugs will come down to personal preference. However, today's EU-compliant isolated binding posts are being used on more power amplifiers than ever before. This sometimes makes it difficult, if not impossible, to use a banana connector. Further, given the girth and weight of our Mythical Creature Series speaker cables, a spade may be better capable of fully supporting the cable. This is particularly a concern with binding posts that do not allow a banana connector to fully seat into the post.

Further, the EU-compliant posts will neither accept our V-Spade nor allow our Multi-Spade to be fully seated. For these applications (or when you're not certain), **we highly recommend the U-Spade**, as it can accommodate any binding post. The V-Spade is a specialty spade connector that works well with large wingnut binding posts (such as the Mundorf), as it allows extra clearance.



Banana



Multi-Spade



U-Spade



V-Spade

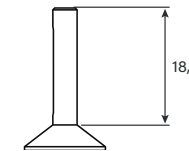

Banana Dimensions (mm)

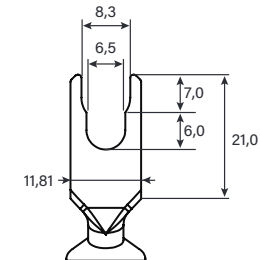

Multi-Spade Dimensions (mm)

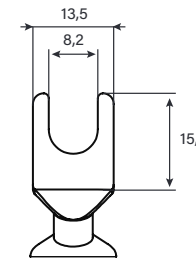

U-Spade Dimensions (mm)

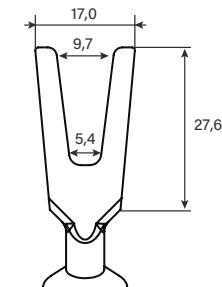

V-Spade Dimensions (mm)

Speaker-End Connector:

Choice of 1000-Series Spade or Banana (Silver only)

Here we typically recommend the **U-Spade** or banana connector. However, even though there is less weight and pressure on this side of the cable (particularly for BiWire sets), it is nevertheless important to note the binding post's design. If a banana connector cannot seat all the way into the binding post, we recommend one of our spade connectors.

How to Order Prepared Speaker Cables

First please specify type of connector (banana or appropriate spade), then the finish of connector (silver*).

(*or gold where applicable)

Pair prices shown. Also available in singles (i.e. for center channel, subwoofer, or mono) at half pair price.

When ordering any factory-terminated speaker cable, please include the required elements shown in the examples below:

Qty.	Pair or Single	Length	Model	FR/BWC/SBW	Amplifier Termination	Speaker Termination	Silver or Gold
1	Pair	3m	Rocket 88	FR	Spade	Banana	Silver
1	Single	2m	William Tell	COMBO	U-Spade	Banana	N/A
1	Single	3m	Rocket 44	SBW	Spade	Banana	Gold

Speaker Cables: Q2 and Type Series (5, 9, Type 9+DBS)

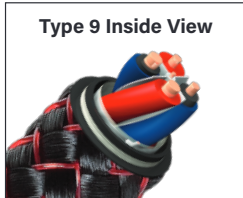
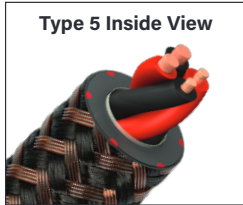
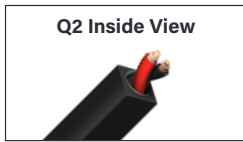

Model	Q2	Type 5	Type 9	Type 9+DBS ● 72v DBS
Metal	Concentric Long-Grain Copper (LGC)	Solid PSC+ Sonic-Signature Conductors and Long-Grain Copper (LGC)	Solid Perfect-Surface Copper+ (PSC+)	
Gauge	1,65mm ²	1,65mm ²	1,65mm ²	1,65mm ²
Geometry	Low-Inductance Twisted-Pair	Star-Quad		
Noise-Dissipation	No	Carbon-Based Noise-Dissipation	Multi-Layer Carbon-Based Noise-Dissipation	
Jacket	Prepared: Black PVC Bulk: White or Black PVC	Prepared: Brown/Black Braid Bulk: Red Striped PVC	Red/Black Braid	
Plugs	Prepared: SureGrip 100 (Silver) Banana Bulk: SureGrip 100 (Silver or Gold) Banana	SureGrip 300 (Silver or Gold) Choice of Multi-Spade or Banana	500 Series (Silver or Gold) Choice of Multi-Spade or Banana	1000 Series (Silver) Choice of Multi-Spade or Banana
Prepared Lengths	Euro Retail	Euro Retail	Euro Retail	Euro Retail
2m Pair	-	569,00	789,00	1.239,00
2,5m Pair	-	599,00	849,00	1.299,00
3m Pair	329,00	629,00	909,00	1.359,00
4m Pair	-	689,00	1.029,00	1.479,00
Other prepared lengths use formula (per pair)	-	60,00/m + 449,00	120,00/m + 549,00	120,00/m + 999,00
Bulk Cables (on spools)	Euro Retail	Euro Retail	Euro Retail	Euro Retail
50m	-	-	-	-
100m	16,50/m	30,00/m	-	-

Speaker Cables: Rocket Series

Please Specify Termination



Model	Rocket 11	Rocket 22	Rocket 33	Rocket 44	Rocket 88 72v DBS
Application Options	Full-Range and Single-BiWire		Full-Range, Single-BiWire, REL and Optimized for Naim		
Metal	Semi-Solid Concentric Long-Grain Copper (LGC)	Semi-Solid Concentric PSC and LGC	Solid PSC and LGC	Solid PSC+ and PSC	Solid PSC+
Gauge	2,08mm ²	3,31mm ²	2,08mm ²	2,63mm ²	
Geometry	Double Spiral-Pair		Double Star-Quad		
Dielectric	PVC		Foamed-Polyethylene (For All Positive Conductors)		
Noise-Dissipation	No		Carbon-Based Noise-Dissipation		
Jacket	Black or White PVC with Grey stripes	Black or White PVC with Blue stripes	Red/Black Braid or PVC	Silver/Black Braid or PVC	Green/Black Braid or PVC
Plugs	SureGrip 300 (Silver or Gold) Choice of Multi-Spade or Banana		SureGrip 300 (Silver or Gold) Choice of Multi-Spade or Banana	500 Series (Silver or Gold) Choice of Multi-Spade or Banana	
Prepared Lengths	Euro Retail	Euro Retail	Euro Retail	Euro Retail	Euro Retail
2m Pair	379,00	499,00	629,00	799,00	1.219,00
2,5m Pair	399,00	549,00	699,00	899,00	1.349,00
3m Pair	419,00	599,00	769,00	999,00	1.479,00
4m Pair	459,00	699,00	909,00	1.199,00	1.739,00
Other prepared lengths use formula (per pair)	40,00/m + 299,00	100,00/m + 299,00	140,00/m + 349,00	200,00/m + 399,00	260,00/m + 699,00
Bulk Cables (on spools)	Euro Retail	Euro Retail	Euro Retail	Euro Retail	Euro Retail
50m	20,00/m	50,00/m	70,00/m	100,00/m	130,00/m
100m	20,00/m	50,00/m	70,00/m	-	-

Speaker Cables: Robin Hood (Folk Heroes)



Model	Robin Hood ZERO ● 72v DBS	Robin Hood BASS ● 72v DBS	Robin Hood ZERO BiWire COMBO (ZERO + BASS) ● 72v DBS	Robin Hood SILVER ● 72v DBS	Robin Hood SILVER BiWire COMBO (SILVER + BASS) ● 72v DBS
Metal	Solid Perfect-Surface Copper+ (PSC+)		Refer to Specs for ZERO and BASS	Solid PSS Sonic-Signature Conductors and PSC+	Refer to Specs for SILVER and BASS
Gauge	1,65mm ²			1,65mm ²	
Geometry	ZERO-Tech (No Characteristic Impedance)			ZERO-Tech (No Characteristic Impedance)	
Noise-Dissipation	Multi-Layer Carbon-Based Noise-Dissipation	RF/ND-Tech		Multi-Layer Carbon-Based Noise-Dissipation	
Jacket	Dark Green/Black Braid	Black Braid		Light Gray/Black Braid	
Application Options	Full-Range, or BiWire COMBO (when combined with BASS cable)	BiWire COMBO (when combined with ZERO cable)	Full-Range, or combined with BASS to form a BiWire COMBO		
Plug Options (1000 Series, Silver)	AMP-Side: Choice of U-Spade (recommended default), Banana, Multi-Spade, or V-Spade / SPEAKER-Side: Choice of U-Spade (recommended default), Banana, or Multi-Spade				
Prepared Lengths	Euro Retail	Euro Retail	Euro Retail	Euro Retail	Euro Retail
2m Pair	1.899,00	1.899,00	3.799,00	6.399,00	8.299,00
2,5m Pair	2.099,00	2.099,00	4.199,00	7.699,00	9.799,00
3m Pair	2.299,00	2.299,00	4.599,00	8.999,00	11.299,00
4m Pair	2.699,00	2.699,00	5.399,00	11.599,00	14.299,00
Other prepared lengths use formula (per pair)	400,00/m + 1.099,00	400,00/m + 1.099,00	800,00/m + 2.199,00	2.600,00/m + 1.199,00	3.000,00/m + 2.299,00

Speaker Cables: William Tell (Folk Heroes)



Model	William Tell ZERO ● 72v DBS	William Tell BASS ● 72v DBS	William Tell ZERO BiWire COMBO (ZERO + BASS) ● 72v DBS	William Tell SILVER ● 72v DBS	William Tell SILVER BiWire COMBO (SILVER + BASS) ● 72v DBS
Metal	Solid Perfect-Surface Copper+ (PSC+)	Solid PSC+ Sonic-Signature Conductors and LGC	Refer to Specs for ZERO and BASS	Solid PSS Sonic-Signature Conductors and PSC+	Refer to Specs for SILVER and BASS
Gauge	2,62mm ²			2,62mm ²	
Geometry	ZERO-Tech (No Characteristic Impedance)			ZERO-Tech (No Characteristic Impedance)	
Noise-Dissipation	Multi-Layer Carbon-Based Noise-Dissipation	RF/ND-Tech		Multi-Layer Carbon-Based Noise-Dissipation	
Jacket	Dark Red/Black Braid	Black Braid		Silver/Black Braid	
Application Options	Full-Range, or BiWire COMBO (when combined with BASS cable)	BiWire COMBO (when combined with ZERO cable)	Full-Range, or BiWire COMBO (when combined with BASS cable)		
Plug Options (1000 Series, Silver)	AMP-Side: Choice of U-Spade (recommended default), Banana, Multi-Spade, or V-Spade / SPEAKER-Side: Choice of U-Spade (recommended default), Banana, or Multi-Spade				
Prepared Lengths	Euro Retail	Euro Retail	Euro Retail	Euro Retail	Euro Retail
2m Pair	3.099,00	2.699,00	5.799,00	8.199,00	10.899,00
2,5m Pair	3.499,00	2.999,00	6.499,00	9.849,00	12.849,00
3m Pair	3.899,00	3.299,00	7.199,00	11.499,00	14.799,00
4m Pair	4.699,00	3.899,00	8.599,00	14.799,00	18.699,00
Other prepared lengths use formula (per pair)	800,00/m + 1.499,00	600,00/m + 1.499,00	1.400,00/m + 2.999,00	3.300,00/m + 1.599,00	3.900,00/m + 3.099,00

Speaker Cables: ThunderBird (Mythical Creatures)



Model	ThunderBird ZERO ● 72v DBS	ThunderBird BASS ● 72v DBS	ThunderBird ZERO BiWire COMBO (ZERO + BASS) ● 72v DBS
Metal	Solid Perfect-Surface Copper+ (PSC+)	Solid PSC+ Sonic-Signature Conductors and LGC	Refer to Specs for ZERO and BASS
Gauge	5,26mm ²		
Geometry	ZERO-Tech (No Characteristic Impedance)		
Noise-Dissipation	Multi-Layer Carbon-Based Noise-Dissipation	RF/ND-Tech	
Jacket	Blue/Black Braid		
Application Options	Full-Range, or BiWire COMBO (when combined with BASS cable)	BiWire COMBO (when combined with ZERO cable)	
Plug Options (1000 Series, Silver)	AMP-Side: Choice of U-Spade (recommended default), Banana, Multi-Spade, or V-Spade / SPEAKER-Side: Choice of U-Spade (recommended default), Banana, or Multi-Spade		
Prepared Lengths	Euro Retail	Euro Retail	Euro Retail
2m Pair	5.300,00	4.300,00	9.600,00
2,5m Pair	6.050,00	4.800,00	10.850,00
3m Pair	6.800,00	5.300,00	12.100,00
4m Pair	8.300,00	6.300,00	14.600,00
Other prepared lengths use formula (per pair)	1.500,00/m + 2.300,00	1.000,00/m + 2.300,00	2.500,00/m + 4.600,00

Speaker Cables: FireBird (Mythical Creatures)



Model	FireBird ZERO ● 72v DBS	FireBird BASS ● 72v DBS	FireBird BiWire COMBO (ZERO + BASS) ● 72v DBS
Metal	Solid Perfect-Surface Silver (PSS) Sonic-Signature Conductors and Perfect-Surface Copper+ (PSC+)		
Gauge	10 AWG		
Geometry	ZERO-Tech (No Characteristic Impedance)		
Noise-Dissipation	Multi-Layer Carbon-Based Noise-Dissipation	RF/ND-Tech	Refer to Specs for ZERO and BASS
Jacket	Dark Red/Black Braid		
Application Options	Full-Range, or BiWire COMBO (when combined with BASS cable)	BiWire COMBO (when combined with ZERO cable)	
Plug Options (1000 Series, Silver)	AMP-Side: Choice of U-Spade (recommended default), Banana, Multi-Spade, or V-Spade / SPEAKER-Side: Choice of U-Spade (recommended default), Banana, or Multi-Spade		
Prepared Lengths	Euro Retail	Euro Retail	Euro Retail
2m Pair	15.500,00	11.500,00	27.000,00
2,5m Pair	18.800,00	13.800,00	32.600,00
3m Pair	22.100,00	16.100,00	38.200,00
4m Pair	28.700,00	20.700,00	49.400,00
Other prepared lengths use formula (per pair)	6.600,00/m + 2.300,00	4.600,00/m + 2.300,00	11.200,00/m + 4.600,00

Speaker Cables: Dragon (Mythical Creatures)

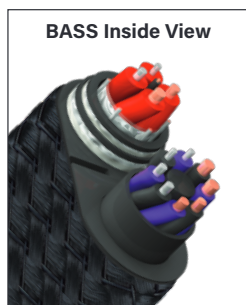

Model	Dragon ZERO ● 72v DBS	Dragon BASS ● 72v DBS	Dragon BiWire COMBO (ZERO + BASS) ● 72v DBS	
Metal	Solid Perfect-Surface Silver (PSS) Sonic-Signature Conductors and Perfect-Surface Copper+ (PSC+)			
Gauge	10 AWG			
Geometry	ZERO-Tech (No Characteristic Impedance)			
Noise-Dissipation	Multi-Layer Carbon-Based Noise-Dissipation	RF/ND-Tech	Refer to Specs for ZERO and BASS	
Jacket	Black Braid			
Application Options	Full-Range, or BiWire COMBO (when combined with BASS cable)	BiWire COMBO (when combined with ZERO cable)		
Plug Options (1000 Series, Silver)	AMP-Side: Choice of U-Spade (recommended default), Banana, Multi-Spade, or V-Spade / SPEAKER-Side: Choice of U-Spade (recommended default), Banana, or Multi-Spade			
Prepared Lengths	Euro Retail	Euro Retail		Euro Retail
2m Pair	28.700,00	22.100,00	50.800,00	
2,5m Pair	35.300,00	27.050,00	62.350,00	
3m Pair	41.900,00	32.000,00	73.900,00	
4m Pair	55.100,00	41.900,00	97.000,00	
Other prepared lengths use formula (per pair)	13.200,00/m + 2.300,00	9.900,00/m + 2.300,00	23.100,00/m + 4.600,00	

Speaker Cable Accessories

Bare Naked BiWire Jumpers

Solid PSC+ conductors offer dramatically superior performance to stamped jumpers.



Set of 4 (8.9 cm each)
Retail: 49,95

ThunderBird and Dragon BiWire Jumpers

Direction-Controlled Solid Perfect-Surface Copper+ (PSC+) Perfect-Surface Silver (PSS) and Carbon-Loaded Insulation. Available in Spade-Spade, Spade-Banana, Banana-Spade, and Banana-Banana.



ThunderBird (PSC+) uses Hanging-Silver 500 Series Bananas or Spades.

Set of 4 (20 cm each)
Retail: 349,00



Dragon (PSS) uses Hanging-Silver 1000 Series Bananas or Spades.

Set of 4 (20cm each)
Retail: 749,00

Fog Lifters

Reduces the RF noise that capacitively couples into cables through all solid materials (carpet, stone, wood, etc.)

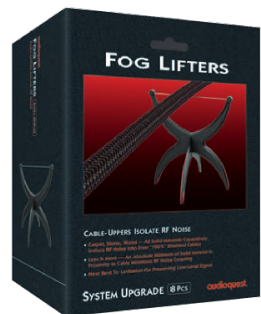

Set of 8
Retail: 159,00

Binding-Post Wrench

Real tool-quality double-ended nut driver with metal inserts.

Fits 11,11 mm and 12,7mm binding posts.



Retail: 19,95

Using BiWire Jumpers with Full-Range Cables on BiWire Capable Speakers

3-Way or Panel-Hybrid Speaker

Please connect amp. directly to the critical midrange and tweeter Treble input, and then jumper down to the Bass input.

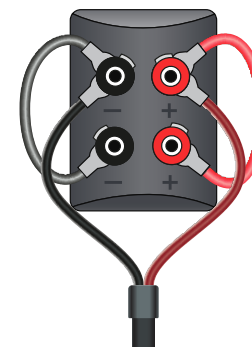

2-Way Speaker

To maintain the speaker design's delicate midrange/tweeter relationship, please connect signal to Treble (+) and Bass (-).

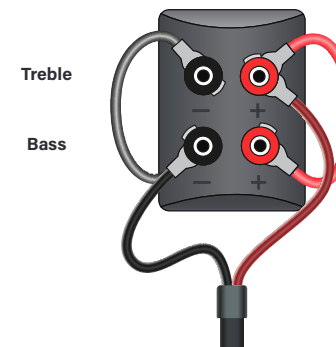

Audio Interconnect Cables

The Higher You Climb, The Less You Hear?

The evolution of AudioQuest's audio cables is a steady climb up a mountain whose summit we'll never reach — there is always room for improvement and growth, as evidenced by our new Mythical Horses and Mythical Creatures interconnects. Perhaps less intuitive is the fact that climbing up our Analog Interconnect line means you hear less of the cable.

The reason is simple: As more of the delicate audio signal is protected from damage along the way, the listener experiences more of the truth and emotional impact of the music. Greater faithfulness to the audio signal is made possible by the use of superior materials and the careful implementation of increasingly sophisticated design and construction techniques.

Music is wonderfully complex, and our ears are very sensitive to its nuances. The remarkably affordable Bridges & Falls Series is an amazing place to start the journey. For those who want better performance and can sacrifice the physical flexibility and diverse connectivity options afforded by Bridges & Falls, the Rivers and Elements are excellent choices. Every step up the ladder to the state-of-the-art Mythical Creatures Series delivers even more clarity, smoother and more natural sound, greater dynamic slam, and more nuanced expression from the music.

As you climb with your customers, you'll hear progressions in metal, from Solid Long-Grain Copper to Perfect-Surface Copper+, and PSS Silver; in Geometry, from Double- to Triple-Balanced; in insulation, from Foamed-PE to FEP Air-Tubes; and in Noise-Dissipation techniques, from Metal-Layer to Carbon-Layer to Graphene/Carbon Mesh-Network and our patented Dielectric-Bias System. And finally, in our newest "Mythical" interconnects, ZERO-Tech, which eliminates the cable's characteristic impedance for an even more "invisible" sonic signature.

Throughout the line, the AQ performance-driven value system is always 100% evident. Climb until the incremental cost of the higher model is no longer the least expensive way to make the most improvement — but don't be surprised if your customers find themselves at the top of the line before reaching that point!



Angel



Yosemite



Sydney



Big Sur



Golden Gate



Evergreen



Pegasus

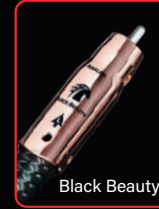

Black Beauty



Yukon



Mackenzie



Red River



Chicago



Dragon

ThunderBird

Audio Interconnect Cables: Bridges & Falls

Tower and Golden Gate also available in Installer 5-Packs, page 60.

	Tower		Evergreen		Golden Gate		Big Sur		Sydney		Yosemite 72v DBS		Angel 72v DBS	
3,5mm Male Mini														
2-Male RCA														
3,5mm Female Mini														
5 Pin DIN														
Model	Tower		Evergreen		Golden Gate		Big Sur		Sydney		Yosemite 72v DBS		Angel 72v DBS	
Metal	Solid Long-Grain Copper (LGC)				Solid Perfect-Surface Copper (PSC)		Solid Perfect-Surface Copper+ (PSC+)						Solid Perfect-Surface Silver (PSS)	
Geometry	Asymmetrical Double-Balanced (Lower Impedance on Ground, Same Quality + and - Conductors)													
Dielectric	Foamed-Polyethylene								Polyethylene Air-Tubes		FEP Air-Tubes			
Noise-Dissipation	Metal-Layer Noise-Dissipation										Carbon-Based Noise-Dissipation			
Jacket	Black with White Stripes PVC		Green/Black Braid		Red/Black Braid		Brown/Black Braid		Dark Gray/Black Braid		Green/Black Braid		Silver/Black Braid	
Termination	Cold-Welded, Gold-Plated						Cold-Welded, Gold-Plated Pure Purple Copper		Cold-Welded, Direct-Silver Plated Pure Purple Copper		Cold-Welded, Direct-Silver Plated Pure Red Copper			
Application														
3,5mm Male Mini - 2-Male RCA							Yes							
2-Male RCA - 2-Male RCA							Yes							
3,5mm Male Mini - 3,5mm Male Mini							Yes							
3,5mm Male Mini - 3,5mm Female Mini	3m and 5m Only		No		2m and 5m Only		No		No		Yes			
3,5mm Male Mini - 5 Pin DIN											Yes			
5 Pin DIN - 5 Pin DIN											Yes			
5 Pin DIN - 2-Male RCA											Yes			
Length	Euro Retail		Euro Retail		Euro Retail		Euro Retail		Euro Retail		Euro Retail		Euro Retail	
0,6m	45,95		79,00		119,00		159,00		249,00		469,00		999,00	
1m	49,95		89,00		129,00		169,00		279,00		519,00		1.199,00	
1,5m	54,95		99,00		139,00		185,00		319,00		579,00		1.449,00	
2m	59,95		109,00		149,00		199,00		359,00		639,00		1.699,00	
3m	69,95		119,00		169,00		229,00		439,00		759,00		2.199,00	
5m	89,95		149,00		219,00		289,00		599,00		999,00		3.199,00	
8m	119,95		209,00		279,00		379,00		839,00		1.359,00		4.699,00	
12m	159,95		279,00		369,00		499,00		1.159,00		1.839,00		6.699,00	
16m	199,95		349,00		459,00		619,00		1.479,00		2.319,00		8.699,00	
20m	239,95		419,00		549,00		739,00		1.799,00		2.799,00		10.699,00	
Other prepared lengths use formula:	-		-		-		-		-		120,00/m + 399,00		500,00/m + 699,00	

Audio Interconnect Cables: Rivers & Mythical Horses

In order to preserve ZERO-Tech's complete isolation between signal conductors, a Double-DBS pack is included for Pegasus XLR cables.



Model	Chicago	Red River		Mackenzie		Yukon		Black Beauty*		Pegasus*	
		RCA	XLR	RCA	XLR	RCA	XLR	RCA	XLR	RCA 72v DBS	XLR Double 72v DBS
Metal	Solid Long-Grain Copper (LGC)	Solid Perfect-Surface Copper (PSC)		Solid Perfect-Surface Copper+ (PSC+)							
Technology	N/A							ZERO-Tech (No Characteristic Impedance)			
Ground Reference	All Cables Have Separate Ground-Reference Conductors Plus One Signal Conductor for RCA and Two for XLR										
Dielectric	Hard-Cell Foamed Polyethylene					Polyethylene Air-Tubes		Hard-Cell Foamed Polyethylene		Polypropylene Air-Tubes	
Noise-Dissipation	Metal-Layer			Carbon Mesh-Network				ZERO-Tech + Graphene/Carbon		72v DBS + ZERO-Tech Graphene/Carbon	
Jacket	Green/Black Braid	Red/Black Braid		Brown/Black Braid		Black/Dark Gray Braid		Black/Black Braid		Brown/Black Braid	
Plug Barrels	N/A							Copper-Plated RF-Draining			
Cold-Welded Plugs	Gold-Plated			Hanging-Silver over Purple Copper				Hanging-Silver over Red Copper			
Length (Pair)	Euro Retail	Euro Retail	Euro Retail	Euro Retail	Euro Retail	Euro Retail	Euro Retail	Euro Retail	Euro Retail	Euro Retail	Euro Retail
0,5m	129,00	219,00	279,00	329,00	399,00	469,00	549,00	-	-	-	-
0,6m	-	-	-	-	-	-	-	779,00	949,00	1.539,00	1.859,00
0,75m	134,00	229,00	289,00	344,00	414,00	504,00	594,00	-	-	-	-
1m	139,00	239,00	299,00	359,00	429,00	539,00	639,00	869,00	1.089,00	1.699,00	2.099,00
1,5m	149,00	259,00	319,00	389,00	459,00	609,00	729,00	979,00	1.259,00	1.899,00	2.399,00
2m	159,00	279,00	339,00	419,00	489,00	679,00	819,00	1.089,00	1.429,00	2.099,00	2.699,00
3m	179,00	319,00	379,00	479,00	549,00	819,00	999,00	1.309,00	1.769,00	2.499,00	3.299,00
4m	199,00	359,00	419,00	539,00	609,00	959,00	1.179,00	1.529,00	2.109,00	2.899,00	3.899,00
5m	219,00	399,00	459,00	599,00	669,00	1.099,00	1.359,00	1.749,00	2.449,00	3.299,00	4.499,00
6m	239,00	439,00	499,00	659,00	729,00	1.239,00	1.539,00	1.969,00	2.789,00	3.699,00	5.099,00
For longer lengths, please use formula:	20,00/pair m + 119,00/pair	40,00/pair m + 199,00/pair	40,00/pair m + 259,00/pair	60,00/pair m + 299,00/pair	60,00/pair m + 369,00/pair	140,00/pair m + 399,00/pair	180,00/pair m + 459,00/pair	220,00/pair m + 649,00/pair	340,00/pair m + 749,00/pair	400,00/pair m + 1.299,00/pair	600,00/pair m + 1.499,00/pair

Bulk Cables	Chicago	Red River	Mackenzie
Euro Retail per metre	10,00 (100m spool)	20,00 (100m spool)	30,00m (50m Spool)

Audio Interconnect Cables: Mythical Creatures

In order to preserve ZERO-Tech's complete isolation between signal conductors, a Double-DBS pack is included for XLR cables.

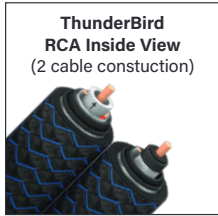

Model	ThunderBird*		FireBird*		Dragon*	
	RCA 72v DBS	XLR Double 72v DBS	RCA 72v DBS	XLR Double 72v DBS	RCA 72v DBS	XLR Double 72v DBS
Metal	Solid Perfect-Surface Copper+ (PSC+)			Solid Perfect-Surface Silver (PSS)		
Technology	ZERO-Tech (No Characteristic Impedance), ZERO-Tech Cables do not work as turntable cables with moving coil cartridges					
Dielectric	FEP Air-Tubes					
Noise-Dissipation	ZERO-Tech + 72v DBS + Graphene/Carbon Mesh-Network				PSS Drains + ZERO-Tech + 72v DBS + Graphene/Carbon	
Jacket	Blue/Black Braid		Red/Black Braid		Black/Black Braid	
Plug Barrels	Copper-Plated RF-Draining			Silver-Plated RF-Draining		
Plug Contacts	Hanging-Silver over Red-Copper					
Length (Pair)	Euro Retail	Euro Retail	Euro Retail	Euro Retail	Euro Retail	Euro Retail
0,5m	2.549,00	3.399,00	4.849,00	5.999,00	7.999,00	9.749,00
0,75m	2.874,00	3.849,00	5.674,00	7.099,00	9.249,00	11.374,00
1m	3.199,00	4.299,00	6.499,00	8.199,00	10.499,00	12.999,00
1,5m	3.849,00	5.199,00	8.149,00	10.399,00	12.999,00	16.249,00
2m	4.499,00	6.099,00	9.799,00	12.599,00	15.499,00	19.499,00
2,5m	5.149,00	6.999,00	11.449,00	14.799,00	17.999,00	22.749,00
3m	5.799,00	7.899,00	13.099,00	16.999,00	20.499,00	25.999,00
4m	7.099,00	9.699,00	16.399,00	21.399,00	25.499,00	32.499,00
5m	8.399,00	11.499,00	19.699,00	25.799,00	30.499,00	38.999,00
6m	9.699,00	13.299,00	22.999,00	30.199,00	35.499,00	45.499,00
Other prepared lengths, use formula:	1.300,00/pair m + 1.899,00/pair	1.800,00/pair m + 2.499,00/pair	3.300,00/pair m + 3.199,00/pair	4.400,00/pair m + 3.799,00/pair	5.000,00/pair m + 5.499,00/pair	6.500,00/pair m + 6.499,00/pair

*ZERO-Tech Cables do not work as turntable cables with moving coil cartridges.

Audio Interconnect Accessories

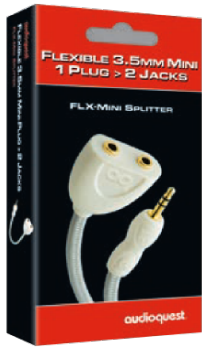

FLX-Mini Splitter
 3,5mm Mini Male Stereo >
 (2) 3,5mm Female Stereo
Metal: Solid Perfect-Surface
 Copper+ (PSC+)
Length: 15cm

Euro Retail: 29,95



FLX-Mini/RCA Adaptor
 3,5mm Mini Male Stereo <->
 2 Female RCA (L & R)
Metal: Solid Perfect-Surface
 Copper+ (PSC+)
Length: 15cm

Euro Retail: 29,95



Hard Mini/RCA Adaptor
 Hard Mini 3,5mm Male <->
 2 Female RCA (L & R)

Euro Retail: 19,95



FLX-X RCA Splitter
 RCA Male >
 2 Female RCA (L & R)
Metal: Solid Long-Grain
 Copper (LGC)
Length: 15cm

Euro Retail: 26,95



FLX-X RCA Splitter
 RCA Female >
 2 Male (L & R)
Metal: Solid Long-Grain
 Copper (LGC)
Length: 15cm

Euro Retail: 26,95



M21F-90 Adaptor
 Female RCA to Right Angle
 Male RCA

Euro Retail: 12,95



Hard RCA Splitter
 Male RCA > 2 Female RCA

Euro Retail: 24,95



RCA - RCA Coupler
 Female RCA <-> Female RCA

Euro Retail: 13,95



PreAmp Jumpers
 Solid Perfect-Surface Copper+ (PSC+) conductors in Polyethylene Air-Tubes. Replaces factory fitted "U" jumpers on integrated amps and receivers.

Euro Retail: 54,95

Subwoofer Cables



Model	Black Lab	Greyhound	Irish Red	Boxer	Husky	
					RCA ● 72v DBS	XLR ● 72v DBS
Metal	Solid Long-Grain Copper (LGC)	0,5% Silver	Solid 0,5% Silver	Solid 1,25% Silver	Solid 5% Silver	
Geometry	Symmetrical Coax	HyperLitz Coax	Symmetrical Coax	Double-Balanced	Triple-Balanced	
Dielectric	Foamed-Polyethylene			Polyethylene Air-Tubes		
Noise-Dissipation	Metal-Layer Noise-Dissipation			Carbon-Based Noise-Dissipation	Carbon-Based Multi-Layer Noise-Dissipation	
Jacket	Black with White Stripes CL3/FT4 Rated PVC	Light Gray-Striped White CL3/FT4 Rated PVC	Up to 5m: Red/Black Braid 8m and Longer CL3/FT4 Rated: Black PVC with Red Stripes	Up to 5m: Brown/Black Braid 8m and Longer CL3/FT4 Rated: Black PVC with Brown Stripes	Blue/Black Braid or CL3/FT4 Rated Black PVC with Blue Stripes (Any Length)	
Termination	Cold-Welded, Gold-Plated			Cold-Welded, Hanging-Silver directly over pure Red Copper		
Application - Attached Chassis-Ground Connector						
RCA - RCA	Yes					
RCA/XLR Mixed	No				Yes	
Meters	Euro Retail	Euro Retail	Euro Retail	Euro Retail	Euro Retail	Euro Retail
2m	56,95	74,95	103,00	209,00	459,00	499,00
3m	65,95	84,95	115,00	239,00	539,00	579,00
5m	83,95	104,95	139,00	299,00	699,00	739,00
8m	110,95	134,95	175,00	389,00	939,00	979,00
12m	146,95	174,95	223,00	509,00	1.259,00	1.299,00
16m	182,95	214,95	271,00	629,00	1.579,00	1.619,00
20m	218,95	254,95	319,00	749,00	1.899,00	1.939,00
Other prepared lengths use formula:	-	-	-	-	80,00/m + 299,00	80,00/m + 339,00

Note: Greyhound is optimized for custom-installation projects that require its thin, discreet design. It does not include a chassis-ground connector.



Tonarm Cables



Model	Yosemite ● 72v DBS	Angel ● 72v DBS	WEL Signature Limited Edition ● 72v DBS
Metal	Solid Perfect-Surface Copper+ (PSC+)	Solid Perfect-Surface Silver (PSS)	
Dielectric	FEP Air-Tubes		
Noise-Dissipation	Carbon-Based Noise-Dissipation		Carbon-Based Multi-Layer Noise-Dissipation
Capacitance	Less than 90pF/1,5M		
Jacket	Green/Black Braid	Silver/Black Braid	Gray/Black Braid
Length	Euro Retail	Euro Retail	Euro Retail
1,2m	549,00	1.299,00	2.499,00
Other prepared lengths use formula:	120,00/m + 405,00	500,00/m + 699,00	750,00/m + 1.599,00

Turntable Cables



Model	Golden Gate	Yosemite ● 72v DBS	Angel ● 72v DBS	WEL Signature Limited Edition ● 72v DBS
Metal	Solid Perfect-Surface Copper (PSC)	Solid Perfect-Surface Copper+ (PSC+)	Solid Perfect-Surface Silver (PSS)	
Dielectric	Foamed-Polyethylene	FEP Air-Tubes		
Noise-Dissipation	N/A	Carbon-Based Noise-Dissipation		Carbon-Based Multi-Layer Noise-Dissipation
Capacitance	Less than 90pF/1.5M			
Jacket	Red/Black Braid	Green/Black Braid	Silver/Black Braid	Gray/Black Braid
Length	Euro Retail	Euro Retail	Euro Retail	Euro Retail
1,2m	-	549,00	1.299,00	2.499,00
1,5m	149,00	-	-	-



2158

audioquest
india gear controls

Vinyl and Headphone Accessories

GroundGoody Tonearm & Ground Wires

Unlike other ground wires that act as radio-frequency antennas, ThunderBird and Dragon GroundGoody's prevent hum while efficiently dissipating radio-frequency noise. GroundGoody's use premium conductor materials that are controlled for direction and cold-welded to Direct-Silver Plated #10 size spade lugs. Further, AudioQuest's RF/ND-Tech dissipates and cancels most induced radio-frequency noise.



ThunderBird GroundGoody
Solid 6% Silver

Length	Euro Retail
0,6m	119,00
1m	139,00
1,5m	159,00
2m	179,00
3m	219,00



Dragon GroundGoody
Solid Perfect-Surface Silver

Length	Euro Retail
0,6m	449,00
1m	599,00
1,5m	799,00
2m	999,00
3m	1.399,00

Classic Anti-Static Record Brush

Highly Conductive Carbon Fibers

Euro Retail: 17,95



Super-Conductive Record Brush

1 248.000 Highly Conductive Carbon Fibers with No-Resistance Path to Finger-Grip

Euro Retail: 29,95



HL-5 Headshell Leads

Silk-wrapped Linear-Crystal Copper Litz Conductors

Set of 4

Euro Retail: 69,95

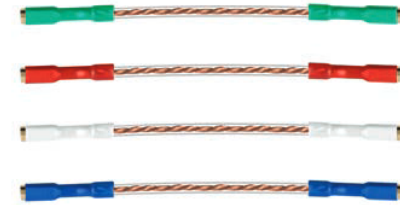

NightBird Headphone Cable

- Fits NightHawk and NightOwl Headphones
- Perfect-Surface Copper+ (PSC+)
- Noise-Dissipation
- Robust: Tested to 28,000 bends

Length	Euro Retail
2m	109,00
3m	139,00
4m	169,00

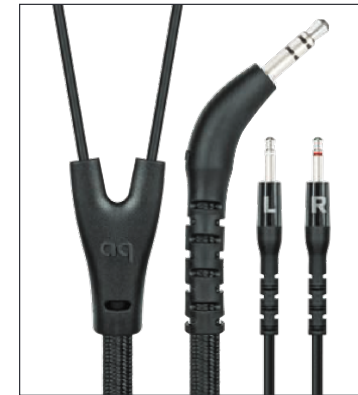

Headphone Plug Adaptor

- Stereo 3.5mm Female > Stereo 6,33mm (1/4") Male
- Nickel Over Extreme-Purity Brass
- Superior Materials and Firm Contact Pressure Ensure Ideal Signal Transfer

Euro Retail: 29,95



Perch Headphone Stand

- Easily and safely accommodates all headphones
- High-quality materials
- Heavy base provides stability

Euro Retail: 99,00



HDMI Cables

Does AudioQuest offer the right HDMI cables for 4K TVs, 8K TVs, and beyond?

Yes! All of AudioQuest's new 48Gbps HDMI cables can transfer up to professional 10K Ultra-HD video. The impressive 48Gbps data rate is made possible by four balanced audio/video pairs capable of 12Gbps each. And, of course, the latest technology is backwards compatible with 4K displays.

Video Up to 10K

AudioQuest 48Gbps HDMI cables are completely backwards compatible with existing devices and have the bandwidth required for video with resolutions up to 10K and resolutions/refresh rates up to 8K/60 and 4K/120.

HDR (High Dynamic Range)

All AudioQuest HDMI cables support HDR (High Dynamic Range) and Dynamic HDR. HDR content expands the contrast of the image for blacker blacks and brighter whites/highlights as well as greater color saturation and brightness. In addition, 4K Ultra-HD content allows for a wider color range.

This combination of technologies results in more realistic HDR images with greater perceived depth. Dynamic HDR (HDR10+ and Dolby Vision, for example) enables frame-by-frame HDR optimization rather than HDR settings that are fixed for the entire program. The most prominent current HDR formats are HDR10, HDR10+, and Dolby Vision.

AudioQuest 18Gbps and 48Gbps HDMI cables are compatible with all varieties of HDR, which can be found on Ultra-HD Blu-ray, and all major streaming services, including Netflix, Amazon Prime, Disney+, Apple TV+, and others.

ARC (Audio Return Channel) and eARC (enhanced Audio Return Channel)

HDMI's Audio Return Channel (ARC) sends audio from a TV to a soundbar or AV receiver for greater simplicity and flexibility in system setup. Hardware's previous ARC capabilities max out at lossy (compressed) 5.1-channel surround sound.

Today's HDMI 2.1 hardware supports enhanced Audio Return Channel (eARC), which increases the digital bandwidth dramatically to support uncompressed and lossless high-resolution multichannel audio, including Dolby TrueHD and Atmos, and DTS-HD Master Audio and DTS: X.

8K-10K



48G
bps

Not only do all current generations of AudioQuest HDMI cables have the conductors and bandwidth required for eARC's enhanced sonic capabilities, but, in order to ensure superior audio performance, the ARC-channel conductor-pair is internally controlled for direction, running in the opposite direction from the 4 pairs that carry information to the TV.

Finally, AudioQuest's eARC-Priority models include 4 Silver-Plated Forest 48-level audio/video data pairs—but with a far superior single data pair for the TV's audio output. By upgrading the ARC data path only, audiophile quality is made possible at a fraction of the cost of upgrading all 5 data pairs.



New Packaging

AudioQuest has turbo-charged all of its HDMI packaging with easy-to-read icons and explanations of the design and material elements that define each cable and its place in the line. Comparing, contrasting and selecting the right cable is easier than ever before.



1.25% SILVER

Solid Conductors

Solid Long-Grain Copper, Silver-Plated Copper, or Perfect-Surface Silver maximize Noise-Dissipation and overall performance.

LEVEL 3 Carbon Mesh-Network

Noise Dissipation

Six Levels of Noise-Dissipation (ND) combat distortion caused by RF Noise contaminating digital and analog circuitry.

eARC

1.25% Silver Level-3 ND

Because sound is where all the emotion and drama comes from, AQ's eARC channel gets 100% the same love as the four AV channels.

Limited

Lifetime Warranty

We've got your back. Performance backed by reliability.

48G bps

4 x 12 = 48

The 48Gbps necessary for all of HDMI's new and future features is made possible by upgrading the 4 AV channels from 6 to 12Gbps.

HDMI: 0,75m–5m Cables

18Gbps 4K and 48Gbps 8K-10K

- All models use Solid Signal and Ground-Reference Conductors.
- All 19 conductors (A/V, eARC, Ground-Reference Drains, Control, Power) are Direction-Controlled.
- AudioQuest "48" HDMI cables have the bandwidth required for video with resolutions up to 10K, resolutions/refresh rates up to 8K/60 and 4K/120.
- For long-length models (Pearl 18, Forest 18, Root Beer 18, Cherry Cola 18, and Cherry Cola 48), see page 37.

BlueBerry 18, Pearl 48, Forest 48, and Cinnamon 48 available in Installer 5-Packs, page 59.



Model	BlueBerry 18	Pearl 48	Forest 48	Cinnamon 48	Carbon 48	Vodka 48	ThunderBird 48	FireBird 48 ● 72v DBS	Dragon 48 ● 72v DBS
A/V Conductor	Solid Long-Grain Copper (LGC)		0,5% Silver	1,25% Silver	5% Silver	10% Silver	10% Silver	100% PSS Silver	100% PSS Silver
eARC Conductor	Solid Long-Grain Copper (LGC)		0,5% Silver	1,25% Silver	5% Silver	10% Silver	10% Silver	100% PSS Silver	100% PSS Silver
Ground Reference	Tinned Copper			0,5% Silver	1,25% Silver	5% Silver	10% Silver	10% Silver	100% PSS Silver
Noise-Dissipation	All 19 Conductors Direction-Controlled			Carbon + Metal + Direction	Carbon + Metal + Direction	Carbon + Metal + Direction	Graphene + Global Carbon + Direction	72v DBS, Graphene + Global Carbon + Direction	
Jacket 0,6-2m	CMG (CL3/FT4) PVC			Red Braid	Carbon Braid	Blue Braid	Blue Braid	Red Braid	Black Braid
Jacket 3m	CMG (CL3/FT4) PVC			Red Braid or PVC	Carbon Braid	Blue Braid	Blue Braid	Red Braid	Black Braid
Jacket 5m	CMG (CL3/FT4) PVC			-	-	-	-	-	-
Length	Euro Retail	Euro Retail	Euro Retail	Euro Retail	Euro Retail	Euro Retail	Euro Retail	Euro Retail	Euro Retail
0,6m	29,95	39,95	69,00	139,00	179,00	449,00	759,00	1.599,00	2.299,00
1m	34,95	44,95	79,00	159,00	199,00	519,00	899,00	1.799,00	2.699,00
1,5m	39,95	49,95	99,00	179,00	249,00	599,00	1.049,00	2.049,00	3.199,00
2m	44,95	59,95	119,00	199,00	299,00	679,00	1.199,00	2.399,00	3.699,00
3m	59,95	79,95	159,00	269,00	399,00	839,00	1.499,00	3.199,00	4.699,00
5m	99,95	199,95	299,00	449,00	-	-	-	-	-

HDMI: Long-Length Cables

18Gbps 4K and 48Gbps 8K-10K

- Pearl 18 and Forest 18 employ active frequency equalization to enable 18Gbps performance for lengths up to 15m.
- Root Beer 18 active optical cable provides 18Gbps performance for lengths up to 30m.
- Certified Ultra High Speed by HDMI Licensing, Cherry Cola 48 active optical cables provide 48Gbps performance for lengths up to 15m.



Model	Pearl 18 Long Distance	Forest 18 Long Distance	Root Beer 18 Optical	Cherry Cola 48 Optical
A/V Conductor	LGC	0,5% Silver	Quartz-Glass	
eARC Conductor	LGC	0,5% Silver	LGC	0,5% Silver
Ground Reference	Tinned Copper			0,5% Silver
Noise-Dissipation	All 19 Conductors Direction-Controlled		Galvanic Isolation + Direction	Carbon + Galvanic Isolation
Jacket	CMG (CL3/FT4) PVC			
Length	Euro Retail	Euro Retail	Euro Retail	Euro Retail
5m	-	-	469,00	999,00
7,5m	239,00	369,00	-	-
10m	289,00	459,00	549,00	1.099,00
12,5m	359,00	549,00	-	-
15m	469,00	-	619,00	1.199,00
20m	-	-	679,00	-
25m	-	-	739,00	-
30m	-	-	819,00	-

HDMI: eARC-Priority Cables

48Gbps 8K-10K

- When using a TV's eARC/ARC output as the audio source to a soundbar or an A/V receiver or an amplifier's ARC input, eARC-Priority models offer their namesake models ARC performance for less than half the price of the namesake model. This is possible because the cables' unused A/V data pairs "only" offer better-than-Cinnamon 48 performance.



Model	Vodka eARC Priority 48	ThunderBird eARC Priority 48	Dragon eARC Priority 48 72v DBS
A/V Conductor	0,5% Silver		
eARC Conductor	10% Silver		100% PSS Silver
Ground Reference	5% Silver eARC	10% Silver eARC	100% PSS Silver eARC
Noise-Dissipation	Carbon + Metal + Direction	Graphene + Global Carbon + Direction	72v DBS, Graphene + Global Carbon + Direction
Jacket 0,75-2m	Blue Braid	Blue Braid	Black Braid
Jacket 3.0m	CMG (CL3/FT4) PVC		
Length	Euro Retail	Euro Retail	Euro Retail
0,6m	219,00	459,00	1.099,00
1m	239,00	499,00	1.199,00
1,5m	269,00	549,00	1.399,00
2m	299,00	599,00	1.599,00
3m	369,00	699,00	1.999,00

HDMI Accessories

Certain HDMI Adaptors available in Installer 5-Packs, page 61.



HDMI 90°/W Adaptor
Wide Side [W]
Right Angle Bend

Euro Retail: 19,95

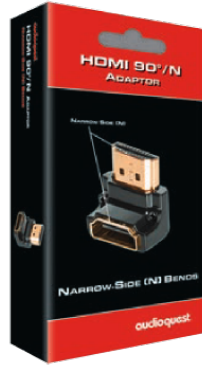

HDMI 90°/N Adaptor
Narrow Side [N]
Right Angle Bend

Euro Retail: 19,95

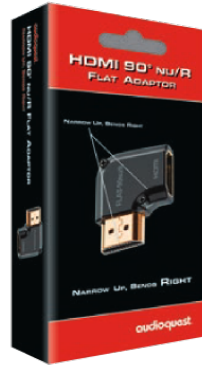

HDMI 90° NU/R Flat Adaptor
Narrow Up [NU]
Bends Right

Euro Retail: 19,95



HDMI 90° NU/L Flat Adaptor
Narrow Up [NU]
Bends Left

Euro Retail: 19,95



HDMI A ↔ A Coupler
Female HDMI to Female
HDMI

Euro Retail: 19,95



**Mini Display Port to
HDMI 4K Adaptor**

Euro Retail: 39,95



**DVI-IN > HDMI-OUT
Adaptor**

F-DVI to M-HDMI

Euro Retail: 39,95

Digital-Audio Interconnect Cables

Perfect Sound Forever?

That bold statement introduced CD players to the world back in 1983. Those claiming perfection believed ones and zeros to be so beyond reproach that traditional concerns about the integrity of the playback system had become irrelevant overnight. But the CD wasn't close to perfect. Those who listened quickly figured out that the equipment and cables in the audio system mattered every bit as much as they had in the analog era.

However, to this day, stating the truth in public that digital-audio cables can make minor to even staggering differences in an audio system's performance is like yelling, "food fight" in a crowded cafeteria—you'd better get ready to duck because there will be incoming.

Yet, the same kind of music lovers and listeners who heard the CD for what it is also know that soul-satisfying digital-audio playback requires the best digital-audio cables. And the best cables reduce the most noise and distortion.

Today, there are more ways to consume digital audio than ever. Many gave up silver discs for the convenience of inferior-sounding compressed downloads, and now we've seemingly got the best of both convenience and performance: We are able to stream high-res files to our phones and mobile devices and into our homes.

AudioQuest's digital-audio cables employ all of our proven techniques for minimizing noise and distortion: better metals, better geometry, better dielectric, Dielectric-Bias System (DBS), Noise-Dissipation, Direction-Controlled Conductors, and other ingredients needed for optimizing each specific application.

The digital future is brighter and more beautiful sounding than ever...*if* your digital-audio cables are capable of treating fragile audio data as it deserves to be treated—that is, with the love and respect reserved for music.



USB Cables

All USB A - C, USB C - B, USB C - C, Micro B, and Lightning cables are available in 0,75m and 1,5m lengths only.
For optimal sonic performance, all AudioQuest USB cables are Hi-Speed with a maximum signaling rate of 480Mbps.



Model	Pearl	Forest	Cinnamon	Carbon	Coffee 72v DBS	Diamond 72v DBS
Metal (USB A-B)	Solid Long-Grain Copper (LGC)	Solid 0,5% Silver	Solid 1,25% Silver	Solid 5% Silver	Solid 10% Silver	Solid 100% Perfect-Surface Silver (PSS)
Metal (All Other Versions)	Long-Grain Copper (LGC) Semi-Solid Concentric	0,5% Silver Semi-Solid Concentric	1,25% Silver Semi-Solid Concentric	5% Silver Semi-Solid Concentric	N/A	Solid 100% Perfect-Surface Silver (PSS)
Dielectric	Hard-Cell Foam					
Noise-Dissipation	Metal-Layer Noise-Dissipation			Carbon-Based Noise-Dissipation for USB A - B		
Jacket	Black PVC with White Stripes	Black PVC with Green Stripes	USB A-B: Red/Black Braid All others: Black PVC with Red Stripes	Gray/Black Braid	Brown/Black Braid	USB A-B: Silver/Black Braid All others: Black PVC with Silver Stripes
Available Configurations	USB A - B USB A - Micro B	USB A - B USB A - C USB A - Micro B 2.0 USB A - Lightning USB C - B USB C - C USB C - Lightning	USB A - B USB A - C USB A - Micro B 2.0 USB A - Lightning USB C - B USB C - C USB C - Lightning	USB A - B USB A - C USB A - Micro B 2.0 USB A - Lightning USB C - B USB C - C USB C - Lightning	USB A - B	USB A - B USB A - C USB A - Micro B 2.0 USB A - Lightning USB C - B USB C - C USB C - Lightning
Length	Euro Retail	Euro Retail	Euro Retail	Euro Retail	Euro Retail	Euro Retail
0,75m	39,95	79,00	109,00	199,00	439,00	769,00
1,5m	49,95	99,00	139,00	249,00	529,00	929,00
3m	69,95 (A-B Only)	119,00 (A-B Only)	179,00 (A-B Only)	349,00 (A-B Only)	769,00	1.259,00 (A-B Only)
5m	99,95 (A-B Only)	159,00 (A-B Only)	239,00 (A-B Only)	499,00 (A-B Only)	979,00	1.699,00 (A-B Only)

USB Connector Applications

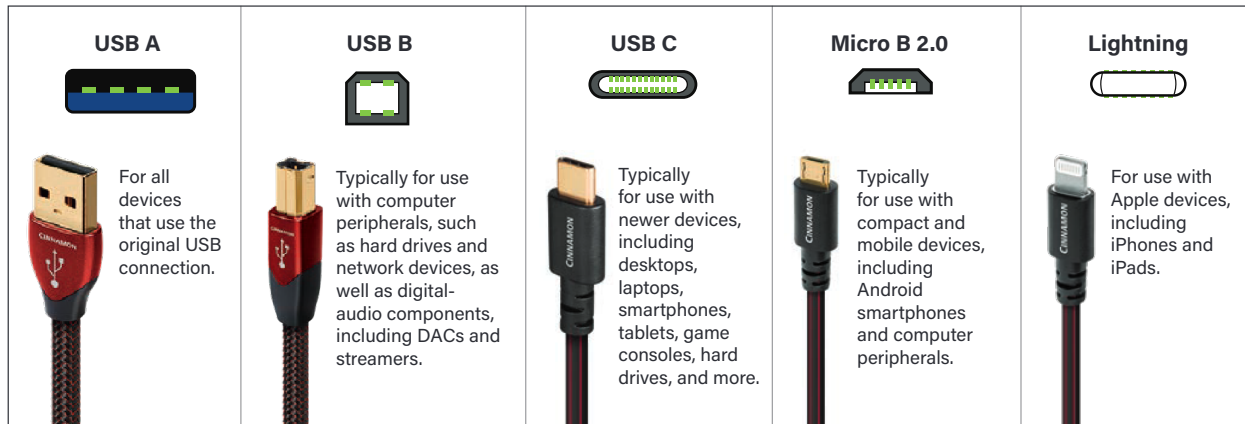

USB Accessories



USB 3.1 Gen 2 C → A Adaptor

Euro Retail: 24,95



USB B ↔ Micro B 2.0 Adaptor

Euro Retail: 19,95



USB Mini B ↔ Micro B 2.0 Adaptor

Euro Retail: 17,95



JitterBug FMJ
USB 2.0 Noise Filter (Data & Power)

Euro Retail: 69,00



Optical Cables

Pearl, Forest, and Cinnamon available in Installer 5-Packs, page 60.

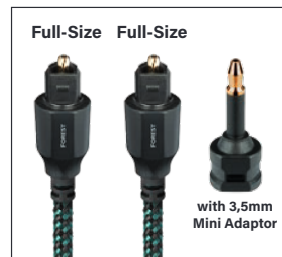

Model	Pearl	Forest	Cinnamon	Carbon	Vodka
Conductors	Low-Dispersion Fiber	Low-Dispersion High-Purity Fiber	Lower-Dispersion Highest-Purity Fiber	19 Narrow-Aperture Highest-Purity Synthetic Fibers	217 Narrowest-Aperture Highest-Purity Synthetic Fibers
Jacket	Black with Gray Stripes In-Wall Rated PVC	0,75m and 1,5m: Green/Black Braid 3m and Longer: In-Wall Rated PVC	0,75m and 1,5m: Red/Black Braid 3m and Longer: In-Wall Rated PVC	0,75m to 5m: Gray/Black Braid 8m and Longer: In-Wall Rated PVC	0,75m to 5m: Blue/Black Braid 8m and Longer: In-Wall Rated PVC
Length	Euro Retail	Euro Retail	Euro Retail	Euro Retail	Euro Retail
0,75m	34,95	54,95	79,00	139,00	269,00
1,5m	39,95	64,95	99,00	189,00	349,00
3m	59,95	99,95	149,00	269,00	549,00
5m	79,95	139,95	199,00	379,00	749,00
8m	109,95	199,95	299,00	549,00	1.099,00
12m	149,95	279,95	429,00	749,00	1.499,00
16m	189,95	359,95	549,00	949,00	1.799,00

Pearl available in both 3,5mm Mini to Full-Size, and Full-Size to Full-Size.
Forest, Cinnamon, Carbon, and Vodka come in Full-Size to Full-Size with 3,5mm Mini Adaptor included.

Optical Accessory



Optical Mini Adaptor

Euro Retail: 17,95

Digital Coax Cables

Forest available in Installer 5-Packs, page 61.



RCA > BNC

Recommended for Forest through Diamond.
Fully acceptable for Wild and WEL when BNC needed only on one end, or to keep an RCA/RCA cable universally useful.

Euro Retail: 19,95



Model	Forest	Cinnamon	Carbon	Coffee ● 72v DBS	Diamond ● 72v DBS	Wild ● 72v DBS	WEL Signature ● 72v DBS
Metal	Solid 0,5% Silver	Solid 1,25% Silver	Solid 5% Silver	Solid 10% Silver	Solid 100% Perfect-Surface Silver (PSS)		
Gauge	24 AWG			21 AWG			
Dielectric	Hard-Cell Foam						
Noise-Dissipation	Metal-Layer Noise-Dissipation		Carbon-Based Multi-Layer Noise-Dissipation			Carbon-Based Multi-Layer Noise-Dissipation, 2 x EMI Absorption	Carbon-Based Multi-Layer Noise-Dissipation, 3 x EMI Absorption
Jacket	Black PVC with Green Stripes	Red/Black Braid	Black/Dark Gray Braid	Brown/Black Braid	Silver/Black Braid	Navy Blue Braid	Black Braid
Terminations	Cold-Welded, Gold-Plated		Cold-Welded, Hanging-Silver Directly Over Pure Purple Copper	Cold-Welded, Hanging-Silver Directly Over Pure Red Copper		Cold-Welded, Hanging-Silver Directly Over Machined Pure Red Copper	
Shield	Foil + Tinned Braid	Foil + Silver-Plated Braid		Silver-Plated Braid		Copper Foil + 100% PSS-Silver Spiral	
Application							
RCA	Yes						
BNC	No (Requires Female RCA to Male BNC adaptor)					Yes	
Length	Euro Retail	Euro Retail	Euro Retail	Euro Retail	Euro Retail	Euro Retail	Euro Retail
0,75m	44,95	89,00	249,00	649,00	1.219,00	2.500,00	3.900,00
1m	-	-	269,00	699,00	1.399,00	2.750,00	4.300,00
1,5m	54,95	109,00	309,00	799,00	1.749,00	3.250,00	5.100,00
2m	-	-	349,00	899,00	2.099,00	3.750,00	5.900,00
3m	74,95	149,00	429,00	1.099,00	2.799,00	4.750,00	7.500,00
5m	99,95	199,00	589,00	1.499,00	4.199,00	6.750,00	10.700,00
Other prepared lengths use formula:	-	-	80,00/m + 189,00	200,00/m + 499,00	700,00/m + 699,00	1.000,00/m + 1.750,00	1.600,00/m + 2.700,00

AES/EBU (Balanced) Cables



Model	Carbon		Diamond ● 72v DBS		Wild ● 72v DBS		WEL Signature ● 72v DBS	
Metal	Solid 5% Silver		Solid 100% Perfect-Surface Silver (PSS)					
Gauge	24 AWG		21 AWG					
Dielectric	Hard-Cell Foam							
Noise-Dissipation	Carbon-Based Multi-Layer Noise-Dissipation			Carbon-Based Multi-Layer Noise-Dissipation, 2 x EMI Absorption		Carbon-Based Multi-Layer Noise-Dissipation, 3 x EMI Absorption		
Jacket	Dark Gray/Black Braid		Silver/Black Braid		Navy Blue Braid		Black Braid	
Termination	Cold-Welded, Hanging-Silver Directly Over Pure Purple Copper		Cold-Welded, Hanging-Silver Directly Over Pure Red Copper		Cold-Welded, Hanging-Silver Directly Over Machined Pure Red Copper			
Shield	Foil + Tinned Braid				Foil + Silver-Plated Spiral			
Length	Euro Retail		Euro Retail		Euro Retail		Euro Retail	
0,75m	289,00		1.599,00		2.900,00		4.900,00	
1m	319,00		1.799,00		3.200,00		5.400,00	
1,5m	379,00		2.199,00		3.800,00		6.400,00	
2m	439,00		2.599,00		4.400,00		7.400,00	
3m	559,00		3.399,00		5.600,00		9.400,00	
5m	799,00		4.999,00		8.000,00		13.400,00	
Other prepared lengths use formula:	120,00/m + 199,00		800,00/m + 999,00		1.200,00/m + 2.000,00		2.000,00/m + 3.400,00	

Ethernet Cables (RJ/E)

Pearl, Forest and Cinnamon available in Installer 5-Packs, page 61.



Model	Pearl	Forest	Cinnamon	Vodka	Diamond 72v DBS
Metal	Solid Long-Grain Copper (LGC)	Solid 0,5% Silver	Solid 1,25% Silver	Solid 10% Silver	Solid 100% Perfect-Surface Silver (PSS)
Dielectric	Geometry Stabilizing Solid High-Density Polyethylene				
Noise-Dissipation	Direction-Controlled Conductors			Carbon-Based Noise-Dissipation	
Jacket	CMG (CL3 & FT4) Rated Black PVC with Gray Stripes	CMG (CL3 & FT4) Rated Black PVC with Green Stripes	Up to 3,0m: Red/Black Braid 5,0m and Longer: CMG (CL3 & FT4) Rated Black PVC with Red Stripes	Up to 3,0m: Blue/Black Braid 5,0m and Longer: CMG (CL3 & FT4) Rated Black PVC with Blue Stripes	Silver/Black Braid
Termination	Gold-Plated Nickel Connectors with 100% Shield Coverage			Precision-Made Low-Loss Ultra-Wide Bandwidth Telegärtner Connectors with 100% Shield Coverage and Strain Relief	
Length	Euro Retail	Euro Retail	Euro Retail	Euro Retail	Euro Retail
0,75m	39,95	79,00	119,00	549,00	1.399,00
1,5m	59,95	99,00	139,00	699,00	2.199,00
3m	79,95	129,00	179,00	949,00	3.699,00
5m	119,95	169,00	239,00	1.349,00	5.399,00
8m	169,95	239,00	329,00	1.999,00	8.699,00
12m	229,95	329,00	449,00	2.749,00	12.999,00

Accessories



Level-X DBS Pack 72v + Noise-Dissipation

- Niagara Custom-Built Noise-Trap Dissipates RF Noise
- 72v Dielectric-Bias System Reduces Dielectric-Noise

Euro Retail Each: 139,00



SorboGel Q-Feet System

Set of 4 energy-absorbing feet each with a "tray" which improves performance and protects furniture. Each foot supports up to 4 kg.

Euro Retail: 159,00



Fog Lifters

For use with audio and AC power cables, Fog Lifters reduce the RF noise that capacitively couples into cables through all solid materials (carpet, stone, wood, etc.)

Set of 8 Euro Retail: 159,00



Cable Clips

Fast and easy way to hold AudioQuest's largest cables in place.

AC Power Cables:

- Thunder, Tornado, Hurricane, FireBird, Dragon

Speaker Cables:

- Robin Hood, William Tell
- ThunderBird, FireBird, Dragon

Interconnect Cables (RCA and XLR):

- ThunderBird, FireBird, Dragon

Set of 6 Euro Retail: 10,00



CleanScreen Kit

150 ml. Bottle + 10 ml. Spray + Retractable Brush

Euro Retail: 29,95



Sorbothane Self-Stick Sheet

15,24cm x 15,24cm x 0,25cm sheet can be cut to size to damp anything, especially effective on top surface of speaker stands.

Euro Retail: 54,95



Binding-Post Wrench

Real tool-quality double-ended nut driver with metal inserts.

Fits 11,1 mm and 12,7mm binding posts.

Euro Retail: 19,95

Accessories



RCA \leftrightarrow BNC Adaptor
Female RCA to/from Male BNC
Euro Retail: 19,95



F > RCA Male Adaptor
Female RCA to Male RCA
Euro Retail: 12,95



F > BNC Male Adaptor
75Ω
Euro Retail: 19,95



F > 2F Splitter
3GHz 75Ω
Euro Retail: 19,95



F > 4F Splitter
3GHz 75Ω
Euro Retail: 25,95



F \leftrightarrow F
75Ω Coupler
Euro Retail: 8,95

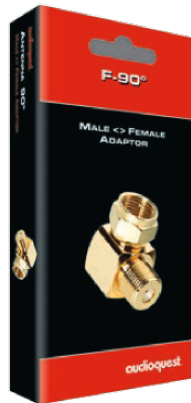

F-90°
Male \leftrightarrow Female Adaptor
Euro Retail: 12,95

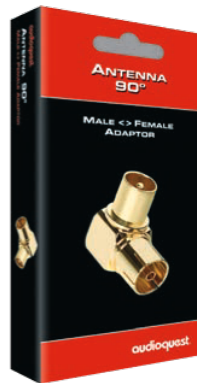

Antenna 90°
Male \leftrightarrow Female Adaptor
Euro Retail: 9,95

Antenna Cable



Model	Antenna HD6 Forest
Conductor	Solid 0,5% Silver
Shield	3-Layer Shield: Foil + 90% Braid + Foil
Jacket	Dark Gray with Green Stripes
Application	
Male Coax - Male Coax	Yes
Male Coax - Female Coax	Yes
Female Coax - Female Coax	Yes
F - F	Yes
Length	Euro Retail
1,5m	50,00
3m	65,00
4,5m	80,00

Accessories

RCA-300

Fits cables up to 7,0mm O.D.
Gold-Plated. Requires soldering.



#300 Male
Set of 4
Euro Retail: 60,00

#300 Female
Set of 4
Euro Retail: 60,00

RCA-800

Fits cables up to 9,0mm O.D.
Direct-Silver Plated. Requires soldering.



#800 Male
Set of 4
Euro Retail: 80,00

XLR Connectors

Fits cables up to 9,0mm O.D.
Direct-Silver Plated. Requires soldering.



#81 Male
Pair
Euro Retail: 120,00

#80 Female
Pair
Euro Retail: 120,00

Right-Angle F and RCA Plugs

Fits cables up to 7,5mm O.D.
Gold-Plated. Requires soldering.



F-90°
Pair
Euro Retail: 50,00

RCA-90°
Pair
Euro Retail: 50,00

Accessories



RJ45 Noise-Stopper Caps

AQ Noise-Stopper Caps fit over unused RJ45 inputs or outputs, preventing RFI and EMI noise from entering the active circuit. Noise-Stopper Caps also protect against dust and corrosion.

Set of 4
Euro Retail: 34,95



USB-A Noise-Stopper Caps

AQ Noise-Stopper Caps fit over unused USB inputs or outputs, preventing RFI and EMI noise from entering the active circuit. Noise-Stopper Caps also protect against dust and corrosion.

Set of 4
Euro Retail: 34,95



HDMI Noise-Stopper Caps

AQ Noise-Stopper Caps fit over unused HDMI inputs or outputs, preventing RFI and EMI noise from entering the active circuit. Noise-Stopper Caps also protect against dust and corrosion.

Set of 4
Euro Retail: 34,95

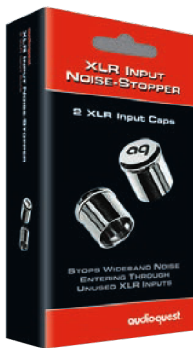

XLR Input (Female) Noise-Stopper Caps

Blocks a significant path for incoming high-frequency energy to interfere with circuit performance.

Euro Retail
per Pair: 44,95

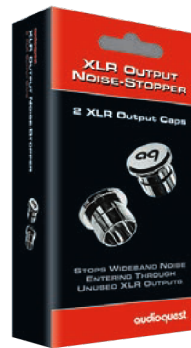

XLR Output (Male) Noise-Stopper Caps

Blocks a significant path for incoming high-frequency energy to interfere with circuit performance.

Euro Retail
per Pair: 44,95

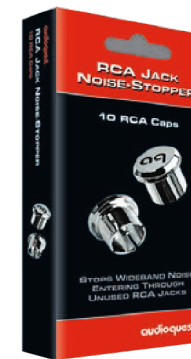

RCA Noise-Stopper Caps

Blocks a significant path for incoming high-frequency energy to interfere with circuit performance.

Set of 10
Euro Retail: 54,95

Tools

All the Tools necessary to Cut, Strip, Prepare, and Terminate any AudioQuest Cable



Cat6/6a/7 Crimper Tool and Die

Includes Cat6 and Cat 7 Die



Cat6 Die

Also sold separately



Rivers Interconnect Crimper Tool

Use with either AudioQuest Chicago RCA, Red River and Mackenzie RCA or XLR plugs.



AQ Ratchet Crimper Tool

For up to 8 AWG Conductors



Klein Crimper Tool

For connectors up to 10 AWG



Klein Cable Cutter



Wire Stripper/Cutter/Plier Combo Tool



Ideal Articulated Stripper

For 8-22 AWG Conductors



Paladin Jacket Stripper

Cleanly and easily removes the jacket on all AudioQuest Interconnect and Speaker Cables



AQ Silver Solder

Easy to use. Clearly sounds better.

454g Solder

Euro Retail: 350,00

113.5g Solder

Euro Retail: 100,00

Instant Tool-less Connectors (ITC) for Analog-Audio, Mini-Coax, and RG6 Cables on Spools

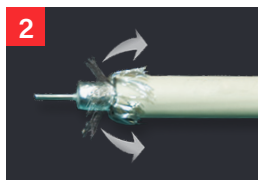

ITC One-Step Stripper for 18 and 24 AWG

For HD6, ITA, and ITV Cables

Euro Retail: 10,00

18 AWG Connectors and Cables for Video, RF, Digital, Subwoofer



ITC-18G
RCA
Euro Retail per piece:
3,75

Supplied in bags of 50



ITC-18G
F
Euro Retail per piece:
3,00

Supplied in bags of 50



ITC-18G
BNC
Euro Retail per piece:
5,50

Supplied in bags of 50



ITC-18G
EU Coax M
Euro Retail per piece:
3,50

Supplied in bags of 50



ITC-18G
EU Coax F
Euro Retail per piece:
3,50

Supplied in bags of 50

	HD6 Pearl	HD6 Forest	HD6 Carbon
Metal	Solid Conductive-Coated Copper	Solid 0,5% Silver	Solid 5% Silver
Shield	3-Layer Shield: Foil + 90% Braid + Foil		4-Layer Shield: Carbon-Loaded PE + Foil + 90% Braid + Foil
CL3 Jacket Color Choices	Dark Gray or White Stripes	Gray, Green or White Stripes	Black, Gray, or White Stripes
Length	Euro Retail	Euro Retail	Euro Retail
76m Spool	-	-	20,00/m
152m Spool	6,50/m	10,00/m	-

24 AWG Connectors and Cables for Analog-Audio and Video



ITC-24G
RCA
Euro Retail per piece:
3,75

Supplied in bags of 50



ITC-24G
F
Euro Retail per piece:
3,75

Supplied in bags of 50



ITC-24G
BNC
Euro Retail per piece:
5,50

Supplied in bags of 50

	ITA-1/1	ITA-3/3	ITA-5/5
Center Conductor Metal	Solid Long-Grain Copper (LGC)	Solid Perfect-Surface Copper (PSC)	Solid Perfect-Surface Copper+ (PSC+)
Neg. Conductor/Shield	LGC HyperLitz	PSC HyperLitz	PSC+ HyperLitz
CL3 Jacket	Blue (Pair)	Green (Pair)	Dark Gray (Pair)
Length	Euro Retail	Euro Retail	Euro Retail
15m Spool	12,50/m	-	-
76m Spool	12,50/m	20,00/m	30,00/m
152m Spool	12,50/m	-	-

Color Bands for 18 and 24 AWG ITC Connectors

Silicon rubber bands fit all ITC connectors—even after they're attached to the cable—for easy cable identification. Available in bags of 20. One color per bag - no mixed colors. Available in 10 colors.

Bag of 20
Euro Retail:
17,50



CL3/FT4 In-Wall Rated Bulk Speaker Cables

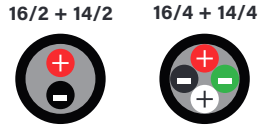

Model	SLiP-DB 16/2	SLiP-DB 16/4	SLiP-DB 14/2	SLiP-DB 14/4	SLiP XTRM 14/2	SLiP XTRM 14/4	SLiP-LSZH 16/2	SLiP-LSZH 14/2
Metal	Semi-Solid Concentric LGC				Semi-Solid True Concentric PSC and LGC		Semi-Solid Concentric LGC	
Gauge	1,31mm ²			2,08mm ²			1,31mm ²	2,08mm ²
Jacket	White PVC with Silver Stripes or Gray PVC with Red Stripes				Dark Gray PVC with Blue Stripes		LSZH (Low Smoke Zero Halogen) White PVC with Silver Stripes	
Length	Euro Retail	Euro Retail	Euro Retail	Euro Retail	Euro Retail	Euro Retail	Euro Retail	Euro Retail
50m Spool	-	-	-	-	30,00/m	-	-	-
100m Spool	-	-	-	-	30,00/m	55,00/m	-	-
152m Spool	6,50/m	10,00/m	9,00/m	14,00/m	-	-	9,75/m	12,50/m



Model	Type 5	Rocket 11	Rocket 22	Rocket 33	Rocket 44	Rocket 88
Metal	Solid PSC+ Sonic-Signature Conductors and LGC	Semi-Solid Concentric LGC	Semi-Solid Concentric PSC and LGC	Solid PSC and LGC	Solid PSC+ and PSC	Solid PSC+
Gauge	1,65mm ²	2,08mm ²	3,31mm ²	2,08mm ²	2,63mm ²	
Geometry	Star-Quad	Double-Spiral		Double Star-Quad		
Dielectric	N/A	PVC		Foamed-Polyethylene (For All Positive Conductors)		
Noise-Dissipation	Carbon-Based Noise-Dissipation	No		Carbon-Based Noise-Dissipation		
Jacket	Red Striped PVC	Black or White PVC	Black or White PVC	Black PVC with Red Stripes	Black PVC with Gloss Black Matte Stripes	Black PVC with Green Stripes
Single BiWire Capable	N/A	Yes				
Length	Euro Retail	Euro Retail	Euro Retail	Euro Retail	Euro Retail	Euro Retail
50m Spool	-	20,00/m	50,00/m	70,00/m	100,00/m	130,00/m
100m Spool	30,00/m	20,00/m	50,00/m	70,00/m	-	-

Termination "Pants" available for Type 5, Rocket 11/22/33/44/88, page 57.

Bulk Speaker Cables — Not In-Wall Rated

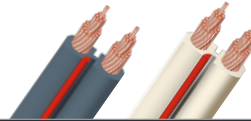
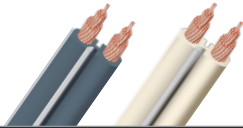

Model	G2	X2	Q2
Metal	Semi-Solid Concentric Long-Grain Copper (LGC)		
Gauge	1,31mm ²	2,08mm ²	1,65mm ²
Jacket	Dark Gray PVC or Off-White PVC	Dark Gray PVC or Off-White PVC	Black PVC or White PVC
Length	Euro Retail	Euro Retail	Euro Retail
10m - <i>White Only</i>	70,00	-	-
30m Pack - <i>White Only</i>	210,00	250,00	-
100m spool	7,00/m	10,00/m	16,50/m

Note: For 100m spools, retail price per meter is listed. Other packaged lengths are shown with retail price per pack.



Model	Rocket 33	Rocket 44	Rocket 88
Metal	Solid Perfect-Surface Copper (PSC) and Long-Grain Copper (LGC)	Solid Perfect-Surface Copper+ (PSC+) and Perfect-Surface Copper (PSC)	Solid Perfect-Surface Copper+ (PSC+)
Gauge	2,08mm ²	2,63mm ²	
Geometry	Double Star-Quad		
Dielectric	Foamed-Polyethylene (For All Positive Conductors)		
Noise-Dissipation	Carbon-Based Noise-Dissipation		
Jacket	Red/Black Braid	Silver/Black Braid	Green/Black Braid
Single BiWire Capable	Yes		
Length	Euro Retail	Euro Retail	Euro Retail
50m Spool	70,00/m	100,00/m	130,00/m
100m Spool	70,00/m	-	-

Termination "Pants" available for Type 5, Rocket 33/44/88, page 57.

SureGrip® Speaker Connectors

Fits up to 6,63mm² Speaker Cables



SureGrip® 100 Banana

Direct-Silver or Gold over Beryllium-Copper

Set of 8
Euro Retail: 60,00

Set of 12
Euro Retail: 90,00

Bag of 80
Euro Retail: 600,00

Bag of 120
Euro Retail: 900,00



SureGrip® 100 Multi-Spade

Direct-Silver or Gold Plating over Purple Copper

Set of 8
Euro Retail: 60,00

Set of 12
Euro Retail: 90,00

Bag of 80
Euro Retail: 600,00

Bag of 120
Euro Retail: 900,00



Allen Tool
Included



SureGrip® 300 Banana

Direct-Silver or Gold over Beryllium-Copper

Set of 4
Euro Retail: 60,00

Tray of 40
Euro Retail: 600,00



SureGrip® 300 Multi-Spade

Direct-Silver or Gold Plating over Purple Copper

Set of 4
Euro Retail: 60,00

Tray of 40
Euro Retail: 600,00



Allen Tool
Included



Black
Labels
Included



500 Series Banana or Multi-Spade

Hanging-Silver directly over pure Purple Copper or Hanging-Gold directly over pure Purple Copper. Silver or Gold.

507 - Sized for 10,55 mm² (same as original 500 connector)

509 - Sized for 6,63 mm²

Set of 4
Euro Retail: 129,00



Set of 6
Euro Retail: 195,00



Combination
Allen and
Phillips Tool
Included



1000 Series Banana or Multi-Spade

Hanging-Silver directly over pure Red Copper.

1003 - Sized for 26,65 mm²

1005 - Sized for 16,76 mm²

1007 - Sized for 10,55 mm² (same as original 1000 connector)

1009 - Sized for 6,63 mm²

Set of 4
Euro Retail: 219,00











Set of 6
Euro Retail: 329,00



Combination
Allen and
Phillips Tool
Included

Spade, Pin, and Banana Connectors

Supplied with Red and Black "Boots" (except 1002)

 <p>1410/S 1410/G Direct-Silver Plated and Direct-Gold Plated Up to 2,08 mm² 4,76mm Binding Post</p> <p>Set of 4 Euro Retail: 60,00</p>	 <p>1010/S 1010/G Direct-Silver Plated and Direct-Gold Plated Up to 5,26 mm² 4,76mm Binding Post</p> <p>Set of 4 Euro Retail: 80,00</p>	 <p>1414/S 1414/G Direct-Silver Plated and Direct-Gold Plated Up to 2,08 mm² 6,35mm Binding Post</p> <p>Set of 4 Euro Retail: 60,00</p>
 <p>1014/S 1014/G Direct-Silver Plated and Direct-Gold Plated Up to 5,26 mm² 6,35mm Binding Post</p> <p>Set of 4 Euro Retail: 60,00</p>	 <p>1056/S 1056/G Direct-Silver Plated and Direct-Gold Plated Up to 5,26 mm² 7,94mm Binding Post</p> <p>Set of 4 Euro Retail: 60,00</p>	 <p>P10M/S P10M/G Hanging-Silver and Hanging Gold Up to 5,26 mm² 6,35mm and 7,94mm Binding Post</p> <p>Set of 4 Euro Retail: 50,00</p>
 <p>BP10/S BP10/G Direct-Silver Plated and Direct-Gold Plated Up to 5,26 mm² Bendable Pin Fits Almost Everything</p> <p>Set of 4 Euro Retail: 40,00</p>	 <p>Crimp-BFA/S Crimp-BFA/G Direct-Silver Plated and Direct-Gold Plated Up to 6,63 mm² Standard Banana Jack</p> <p>Set of 4 Euro Retail: 40,00</p>	 <p>1002/S 1002/G Direct-Silver Plated and Direct-Gold Plated Up to 6,63 mm² Standard Banana Jack</p> <p>Set of 4 Euro Retail: 100,00</p>

Termination "Pants" for Speaker Cables



	Full-Range	Single BiWire
Model	Euro Retail	Euro Retail
Rocket 11 Pants set/4	14,95	19,95
Rocket 22 Pants set/4	14,95	19,95
Rocket 33 Pants set/4	14,95	19,95
Rocket 44 Pants set/4	14,95	19,95
Rocket 88 Pants set/4	14,95	19,95
Type 5 Pants set/4	14,95	-

CL3/FT4 In-Wall Rated Bulk Audio Interconnect Cables & Plugs



Braid not UL Rated



Braid not UL Rated

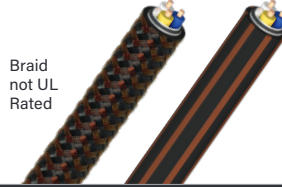

Braid not UL Rated

Model	Chicago	Red River	Mackenzie
Metal	Solid Long-Grain Copper (LGC)	Solid Perfect-Surface Copper (PSC)	Solid Perfect-Surface Copper+ (PSC+)
Geometry	Double-Balanced	Triple-Balanced (Separate Ground-Reference Conductor)	
Dielectric	Hard-Cell Foam		
Noise-Dissipation	Metal-Layer Noise-Dissipation		Carbon-Based Multi-Layer Noise-Dissipation
Jacket	Green/Black Braid or CL3 Black PVC with Green Stripes	Red/Black Braid or CL3 Black PVC with Red Stripes	Brown/Black Braid or CL3 Black PVC with Brown Stripes
Length	Euro Retail	Euro Retail	Euro Retail
50m	-	-	30,00m
100m	10,00/m	20,00/m	-

Note: For spools, retail price per meter is listed.

Field Termination Connectors

To download Chicago, Red River, and Mackenzie cable termination manuals, go to <https://www.audioquest.com/custom-install/manuals>



Rivers Interconnect Crimper Tool

Required with either AudioQuest Chicago RCA, Red River and Mackenzie RCA or XLR plugs.



Chicago RCA

Gold-Plated



Red River RCA

Gold-Plated



Red River XLR

Gold-Plated



Mackenzie RCA

Hanging-Silver over Purple Copper



Mackenzie XLR

Hanging-Silver over Purple Copper

Set of 4
Euro Retail: 89,00

Set of 4
Euro Retail: 89,00

Set of 4
Euro Retail: 169,00

Set of 4
Euro Retail: 109,00

Set of 4
Euro Retail: 199,00

CL3/FT4 In-Wall Rated Bulk CAT6 and CAT7 Ethernet Cables & Plugs

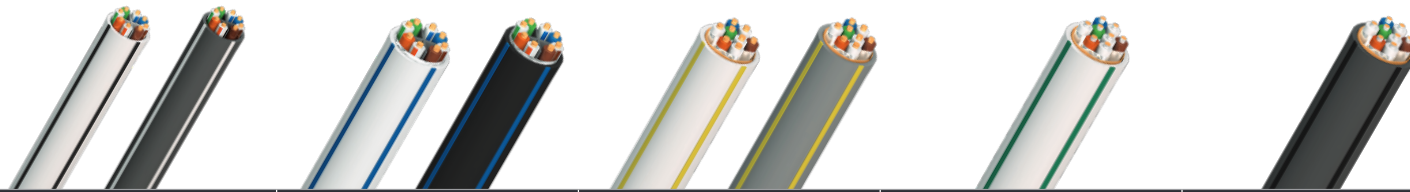

	CAT 600 DCP	CAT 600 FMJ	CAT 700 Pearl	CAT 700 Forest	CAT 700 Carbon
Metal	Solid Long-Grain Copper (LGC)		Solid 0,5% Silver		Solid 5% Silver
Shield	N/A	Overall Shield	Overall Shield and Individual Pairs		
Gauge	23 AWG				
Dielectric	Solid High-Density Polyethylene		Hard-Cell Foam		
Jacket	CMG (CL3/FT4) Rated White PVC with Black Stripes or Dark Gray PVC with White Stripes	CMG (CL3/FT4) Rated White or Black PVC with Blue Stripes	CMG (CL3/FT4) Rated White or Medium Gray PVC with Yellow PVC	CMG (CL3/FT4) Rated White PVC with Green Stripes	CMG (CL3/FT4) Rated Dark Gray PVC with Black Stripes
Length	Euro Retail	Euro Retail	Euro Retail	Euro Retail	Euro Retail
152m	-	5,00/m	10,00/m	15,00/m	65,00/m
305m	3,75/m	-	-	-	-

Note: For spools, retail price per meter is listed.

CAT6/7 Connectors

To download CAT600 and CAT700 cable termination manuals, go to <https://www.audioquest.com/custom-install/manuals>



Cat6/6a/7 Crimper Tool and Die

Required to terminate our Cat6/7 cables and connectors, includes Cat6 and Cat7 Die.



Cat6 Die

Also sold separately



Load Bar Connector Boot

CAT600 DCP Connectors

Fits **CAT600DCP** cable and **standard unshielded** Cat6 cables

Each Euro **Bag of 50**
Retail: 1,75 **Euro Retail: 87,50**



Load Bar Connector Boot

CAT600 FMJ Connectors

Fits **CAT600FMJ**, **CAT700** and **standard shielded Cat6/Cat7** cables

Each Euro **Bag of 50**
Retail: 3,75 **Euro Retail: 187,50**



Load Bar Connector Boot

CAT700 Connectors

Fits **CAT600FMJ**, **CAT700** and **standard shielded Cat6/Cat7** cables

Each Euro **Bag of 50**
Retail: 4,00 **Euro Retail: 200,00**



CAT700 Telegärtner Male Connector

Fits all standard Cat6a/Cat7 cables

Each
Euro Retail: 29,50

Installer Packs

Cables and Accessories in Installer-Friendly bags instead of hanging boxes.

Installer Packs provide exactly what you need to get the job done. Each Pack includes a number of high-value, high-performance AudioQuest pieces and comes with convenient integrated labels that you can peel off and place on your invoice. No retail packaging, no garbage in your truck, no excess waste or cost.

Audio Interconnect Cables

Packs of 5

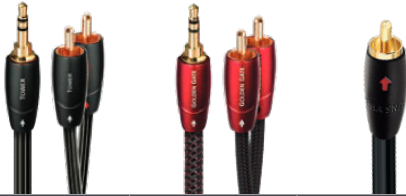

	Tower	Golden Gate	Alpha-Snake
Length	Euro Retail per Cable	Euro Retail per Cable	Euro Retail per Pair
0,5m	-	-	27,95
0,6m	45,95	119,00	-
1m	49,95	129,00	34,95
2m	59,95	149,00	39,95
3m	69,95	169,00	44,95

0,6m available in RCA - RCA only.

1 - 3m available in RCA - RCA, 3,5mm - RCA, 3,5mm - 3,5mm.

Audio Interconnect FLX-X RCA Splitters

Packs of 5



M22F	F22M
Euro Retail Each	Euro Retail Each
24,95	24,95

Optical Cables

Packs of 5



	Pearl	Forest	Cinnamon
Length	Euro Retail per Cable	Euro Retail per Cable	Euro Retail per Cable
0,75m	34,95	54,95	79,00
1,5m	39,95	64,95	99,00
3m	59,95	99,95	149,00

Available in Full-to-Full configurations only.

AC Power C7 90° Adaptors

Packs of 10



E = Equal radius	U = Unequal radius
Euro Retail Each	Euro Retail Each
22,95	22,95



HDMI Cables

Packs of 5



	BlueBerry	Pearl 48	Forest 48
	Euro Retail per Cable	Euro Retail per Cable	Euro Retail per Cable
Length			
0,6m	29,95	39,95	69,00
1m	34,95	44,95	79,00
1,5m	39,95	49,95	99,00
2m	44,95	59,95	119,00
3m	59,95	79,95	159,00
5m	99,95	199,95	299,00

BlueBerry meets the 18G bandwidth required for video up to 8K/30;
 Pearl 48, Forest 48, and Cinnamon 48 extend this capability up to 8K/60 and 4K/120.

HDMI Adaptors

Packs of 5

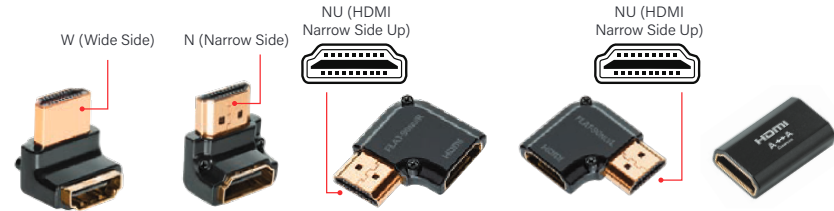

HDMI 90°/W	HDMI 90°/N	HDMI 90° NU/R	HDMI 90° NU/L	HDMI Coupler
Retail Each	Retail Each	Retail Each	Retail Each	Retail Each
19,95	19,95	19,95	19,95	19,95

Ethernet Cables (RJ/E)

Packs of 5



	Pearl	Forest	Cinnamon
	Euro Retail per Cable	Euro Retail per Cable	Euro Retail per Cable
Length			
0,75m	39,95	79,00	119,00
1,5m	59,95	99,00	139,00
3m	79,95	119,00	179,00
5m	119,95	169,00	239,00

Digital Coax Cables

Packs of 5



	Forest
	Euro Retail per Cable
Length	
0,75m	44,95
1,5m	54,95
3m	74,95
5m	99,95

AudioQuest Branded Point of Purchase (POP) Materials



Slat Wall Sign



Acrylic Wall Sign - Red



Acrylic Wall Sign - Black



Tent Card



Window Sticker



Cube Spool Holder

Rugged metal spool holder comes with convenient merchandising labels and accommodates almost any AQ spool.

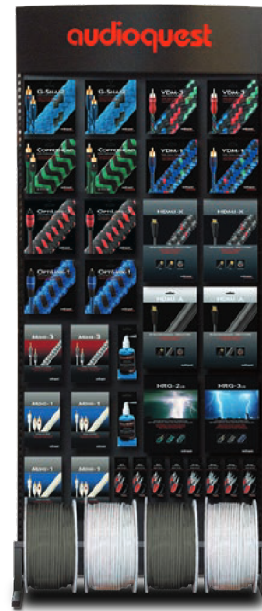

In-Store Display Rack

Spool holder sold separately.
Dimensions: 193cm (h) x 89cm (w) x 33cm (d)



Standalone Display Rack

AudioQuest Branded Promotional Items



Polo Shirt

Our versatile polo shirt looks great with anything. Classic black with a discreet silver AudioQuest logo.

Men's sizes: S-2XL; Women's sizes: S-XL.



T-Shirt

Our classic crewneck t-shirt is made from 100% lightweight, preshrunk cotton for a perfect fit that's as attractive as it is comfortable. Our t-shirt features a tasteful red AudioQuest logo against a solid black background.

Sizes: S-3XL



Chino Washed Cotton Baseball Cap

Our baseball cap has a durable 8-stitch bill for a long-lasting, contoured shape. The Velcro fastener provides easy adjustments for a perfect fit. Available in black with red AudioQuest logo and trim, this cap looks and feels great. One size fits all.



Beanie

Red, gray, and black, with our classic red AudioQuest logo, our stylish beanie is made from super-stretch, fine-gauge acrylic, for a warm, snug fit over your head and ears. The perfect accessory for those cooler days. One size fits all.



Pen

Take note: With its discreet AQ logo, piano-black lacquered tube, and chrome accents, this ballpoint pen has the looks to match the quality of your prose. Keep it in your AudioQuest backpack and take it with you wherever you go.



Water Bottle

Made by Specialized, this 769ml leak-proof water bottle has a self-sealing valve and features easy-to-squeeze BPA-free, recyclable plastic. Our distinct Wolves artwork is printed with a non-solvent based, CPSC-approved ink. Just aim and squeeze for clean, pure refreshment.

AudioQuest Branded Promotional Items



License Plate

It's all about the journey. Take your love for AudioQuest on the road with this license-plate frame. The clean, simple design features our red AudioQuest logo and "Experience the Difference" mantra set against a black background—perfect for any ride. Vroom!



Backpack

Available in black with our black AudioQuest and Four Elements logos. Accommodates laptops with 13" screens and tablets. Made of nylon.



Padded Backpack

Do no harm with our padded backpack. It features a discreet front-panel zipper, multiple internal pockets, and mesh side pockets for drinks and other items. A padded laptop insert safely accommodates screens up to 15". Mesh backing and straps are durable and comfortable, making the backpack as easy to carry as it is to wear.



Tote Bag

This super-durable tote bag is made of water-repellent polyester and has a long strap that fits easily over a shoulder. Measuring 38cm x 36.5cm, its slim pocket is perfect for carrying AudioQuest merchandise—pens, tumblers, price books—and even an LP or two! The simple black-on-black design features a subtly stylish AQ logo.

Index

A

AC Power Cables

Mistral AC Power Bulk Cable	12
NRG-X2	11
NRG-Y2	11
NRG-Z2	11
NRG-X3	11
NRG-Y3	11
NRG-Z3	11
Monsoon	12
Monsoon XTRM	12
Blizzard	12
Blizzard XTRM	12
Silver Cloud	12
Silver Cloud XTRM	12
Thunder (High-Current)	13
Tornado (High-Current)	13
Tornado (Source)	13
Hurricane (High-Current)	13
Hurricane (Source)	13
FireBird (High-Current)	13
FireBird (Source)	13
Dragon (High-Current)	13
Dragon (Source)	13

AC Power Conditioners

PowerQuest G8	9
PowerQuest 2	9
PowerQuest 3	9
Niagara 1200	9
Niagara 3000	9
Niagara 5000	9
Niagara 7000	9

Adaptors

C7 90° Adaptor Kit	14
See also Installer Packs, pg. 60	
DragonTail A to C Adaptor	7
DragonTail USB A 2.0 Extender	7
DragonTail USB A to Micro Adaptor	7
DVI-IN to HDMI-OUT Adaptor	40
F-90° Adaptor	49
FLX-Mini/RCA Adaptor	30
F to BNC Male Adaptor	49
F to RCA Male Adaptor	49
Hard Mini/RCA Adaptor	30
HDMI 90°/W Adaptor	40
See also Installer Packs, pg. 61	
HDMI 90°/N Adaptor	40
See also Installer Packs, pg. 61	

HDMI 90° NU/L Flat Adaptor	40
See also Installer Packs, pg. 61	
HDMI 90° NU/R Flat Adaptor	40
See also Installer Packs, pg. 61	
IEC90/1	14
IEC90/2	14
M21F-90 Adaptor	30
Mini Display Port to HDMI 4K Adaptor	40
Optical Mini Adaptor	44
RCA - BNC Adaptor	45 & 49
USB 3.1 C to A Adaptor	43
USB B - Micro B 2.0 Adaptor	43
USB Mini B - Micro B 2.0 Adaptor	43

AES/EBU (Balanced) Cables

Carbon	46
Diamond	46
Wild	46
WEL Signature	46

Audio Interconnect Cables

Tower	27
See also Installer Packs, pg. 60	
Evergreen	27
Golden Gate	27
See also Installer Packs, pg. 60	
Big Sur	27
Sydney	27
Yosemite	27
Angel	27
Chicago	28
See also Bulk Cables, pg. 58	
Red River	28
See also Bulk Cables, pg. 58	
Mackenzie	28
See also Bulk Cables, pg. 58	
Yukon	28
Black Beauty	28
Pegasus	28
ThunderBird	29
FireBird	29
Dragon	29
Alpha-Snake, Installer Packs	60

B

BiWire Jumpers

Bare Naked BiWire Jumpers	25
ThunderBird	25
Dragon	25

Bulk Cables

HD6 Pearl	53
HD6 Forest	53
HD6 Carbon	53
ITA-1/1	53
ITA-3/3	53
ITA-5/5	53
SLiP/DB-16/2	54
SLiP/DB-16/4	54
SLiP/DB-14/2	54
SLiP/DB-14/4	54
SLiP XTRM 14/2	54
SLiP XTRM 14/4	54
G2	55
X2	55
Q2	55
Type 5	54
Rocket 11	54
Rocket 22	54
Rocket 33	55
Rocket 44	55
Rocket 88	55
Chicago	58
Mackenzie	58
Red River	58
CAT600 DCP	59
CAT600 FMJ	59
CAT700 Pearl	59
CAT700 Forest	59
CAT700 Carbon	59

C

Cable Clips

Cable Clips	48
-------------	----

Cable Risers

Fog Lifters	14, 25, 48
-------------	------------

Cleaner

CleanScreen Kit	48
-----------------	----

Connectors

507 Series Banana	56
1000 Series Banana	56
Banana Connectors	57
CAT600 DCP Connectors	59
CAT600 FMJ Connectors	59
CAT700 Connectors	59
CAT700 Telegärtner Male Connector	59
Chicago RCA	58
Color Bands for 18 and 24 AWG ITC	

Connectors	53
F-90°	50
ITC-18G/BNC	53
ITC-18G/F	53
ITC-18G/RCA	53
ITC-24G/BNC	53
ITC-24G/F	53
ITC-24G/RCA	53
Mackenzie RCA	58
Mackenzie XLR	58
Pin Connectors	57
RCA-90°	50
RCA-300	50
RCA-800	50
Red River RCA	58
Red River XLR	58
Spade Connectors	57
SureGrip 100 Banana	56
SureGrip 100 Multi-Spade	56
SureGrip 300 Banana	56
SureGrip 300 Multi-Spade	56
XLR Connectors	50

Couplers

F - F Coupler	49
HDMI A - A Coupler	40
See also Installer Packs, pg. 61	
RCA - RCA Coupler	30

D

DBS Pack, Level-X

Digital Coax Cables

Forest	45
See also Installer Packs, pg. 61	
Cinnamon	45
Carbon	45
Coffee	45
Diamond	45
Wild	45
WEL Signature	45

DragonFly

Black	7
Red	7
Cobalt	7

Index

E

Ethernet Cables (RJ/E)

<i>Pearl</i>	47
See also <i>Installer Packs</i> , pg. 61	
<i>Forest</i>	47
See also <i>Installer Packs</i> , pg. 61	
<i>Cinnamon</i>	47
See also <i>Installer Packs</i> , pg. 61	
<i>Vodka</i>	47
<i>Diamond</i>	47

F

Fog Lifters 14, 25, 48

G

GroundGoody

<i>ThunderBird</i>	35
<i>Dragon</i>	35

H

HDMI Cables

<i>BlueBerry</i>	38
See also <i>Installer Packs</i> , pg. 61	
<i>Pearl 48</i>	38
See also <i>Installer Packs</i> , pg. 61	
<i>Forest 48</i>	38
See also <i>Installer Packs</i> , pg. 61	
<i>Cinnamon 48</i>	38
<i>Carbon 48</i>	38
<i>Vodka 48</i>	38
<i>ThunderBird 48</i>	38
<i>FireBird 48</i>	38
<i>Dragon 48</i>	38
<i>Pearl 18 Long Distance</i>	39
<i>Forest 18 Long Distance</i>	39
<i>Root Beer 18 Optical</i>	39
<i>Cherry Cola 48 Optical</i>	39
<i>Vodka eARC</i>	39
<i>ThunderBird eARC</i>	39
<i>Dragon eARC</i>	39

Headphone Accessories

<i>Headphone Plug Adaptor</i>	35
<i>HL-5 Headshell Leads</i>	35
<i>NightBird Headphone Cable</i>	35
<i>Perch Headphone Stand</i>	35

J

<i>JitterBug FMJ</i>	7
See also <i>USB Accessories</i> , pg. 42	

N

Noise-Stopper Caps

<i>HDMI Noise-Stopper Caps</i>	51
<i>RCA Noise-Stopper Caps</i>	51
<i>RJ45 Noise-Stopper Caps</i>	51
<i>USB-A Noise-Stopper Caps</i>	51
<i>XLR Input (Female) Noise-Stopper Caps</i>	51
<i>XLR Output (Male) Noise-Stopper Caps</i>	51

O

Optical Cables

<i>Pearl</i>	44
<i>Forest</i>	44
<i>Cinnamon</i>	44
<i>Carbon</i>	44
<i>Vodka</i>	4

P

POP Materials

<i>Acrylic Wall Sign - Black, Red</i>	62
<i>Cube Spool Holder</i>	62
<i>Display Rack, In-Store</i>	62
<i>Display Rack, Standalone</i>	62
<i>Slat Wall Sign</i>	62
<i>Tent Card</i>	62
<i>Window Sticker</i>	62

PreAmp Jumpers 30

Promotional Items

<i>Backpack</i>	64
<i>Backpack, Padded</i>	4
<i>Baseball Cap</i>	63
<i>Beanie</i>	63
<i>Hooded Jacket</i>	63
<i>License Plate Holder</i>	64
<i>Pen</i>	63
<i>Polo Shirt</i>	63
<i>Tote Bag</i>	64
<i>T-Shirt</i>	63
<i>Tumbler</i>	63
<i>Water Bottle</i>	63

Q

Q-Feet, SorboGel 48

R

Record Brushes

<i>Classic Anti-Static Record Brush</i> ...	35
<i>Super-Conductive Record Brush</i> ...	35

S

Solder, Silver 52

Sorbothane Self-Stick Sheet 48

Speaker Cables

<i>Q2</i>	18
See also <i>Bulk Cables</i> , pg. 55	
<i>Type 5</i>	18
See also <i>Bulk Cables</i> , pg. 54	
<i>Type 9</i>	18
<i>Type 9+DBS</i>	18
<i>Rocket 11</i>	19
See also <i>Bulk Cables</i> , pg. 54	
<i>Rocket 22</i>	19
See also <i>Bulk Cables</i> , pg. 54	
<i>Rocket 33</i>	19
See also <i>Bulk Cables</i> , pgs. 54, 55	
<i>Rocket 44</i>	19
See also <i>Bulk Cables</i> , pgs. 54, 55	
<i>Rocket 88</i>	19
See also <i>Bulk Cables</i> , pgs. 54, 55	
<i>Robin Hood ZERO</i>	20
<i>Robin Hood BASS</i>	20
<i>Robin Hood ZERO BiWire COMBO</i> ..	20
<i>Robin Hood SILVER</i>	20
<i>Robin Hood SILVER BiWire COMBO</i> ..	20
<i>William Tell ZERO</i>	21
<i>William Tell BASS</i>	21
<i>William Tell ZERO BiWire COMBO</i> ..	21
<i>William Tell SILVER</i>	21
<i>William Tell SILVER BiWire COMBO</i> ..	21
<i>ThunderBird ZERO</i>	22
<i>ThunderBird BASS</i>	22
<i>ThunderBird ZERO BiWire COMBO</i> ..	22
<i>FireBird ZERO</i>	23
<i>FireBird BASS</i>	23
<i>FireBird BiWire COMBO</i>	23
<i>Dragon ZERO</i>	24
<i>Dragon BASS</i>	24
<i>Dragon BiWire COMBO</i>	24

Splitters

<i>FLX-Mini Splitter</i>	30
<i>FLX-X RCA Splitter</i>	30
See also <i>Installer Packs</i> , pg. 60	
<i>F to 2F Splitter</i>	49
<i>F to 4F Splitter</i>	49

<i>Hard RCA Splitter</i>	30
--------------------------------	----

Subwoofer Cables

<i>Black Lab</i>	31
<i>Greyhound</i>	31
<i>Irish Red</i>	31
<i>Boxer</i>	31
<i>Husky</i>	31

T

Termination Pants

<i>Rocket 11</i>	57
<i>Rocket 22</i>	57
<i>Rocket 33</i>	57
<i>Rocket 44</i>	57
<i>Rocket 88</i>	57
<i>Type 5</i>	57
<i>Type 9</i>	57

Tonearm Cables

<i>Golden Gate</i>	33
<i>Yosemite</i>	33
<i>Angel</i>	33
<i>WEL Signature Limited Edition</i>	33

Tools

<i>AQ Ratchet Crimper Tool</i>	51
<i>Binding-Post Wrench</i>	49
<i>Cat6/6a/7 Crimper Tool and Die</i> ..	52, 59
<i>Cat6 Die</i>	52, 59
<i>Ideal Articulated Stripper</i>	52
<i>ITC One-Step Stripper for 18 and 24 AWG</i>	53
<i>Klein Cable Cutter</i>	52
<i>Klein Crimper Tool</i>	52
<i>Paladin Jacket Stripper</i>	52
<i>Rivers Interconnect Crimper Tool</i>	52, 58
<i>Wire Stripper/Cutter/Plier Combo Tool</i>	52

Turntable Cables

<i>Golden Gate</i>	33
<i>Yosemite</i>	33
<i>Angel</i>	33

U

USB Cables

<i>Pearl</i>	42
<i>Forest</i>	42
<i>Cinnamon</i>	42
<i>Carbon</i>	42
<i>Coffee</i>	42
<i>Diamond</i>	42



audioquest®

WWW.NEXUSACOUSTICS.COM

THE NEXUSACOUSTICS BLOGSPOT